

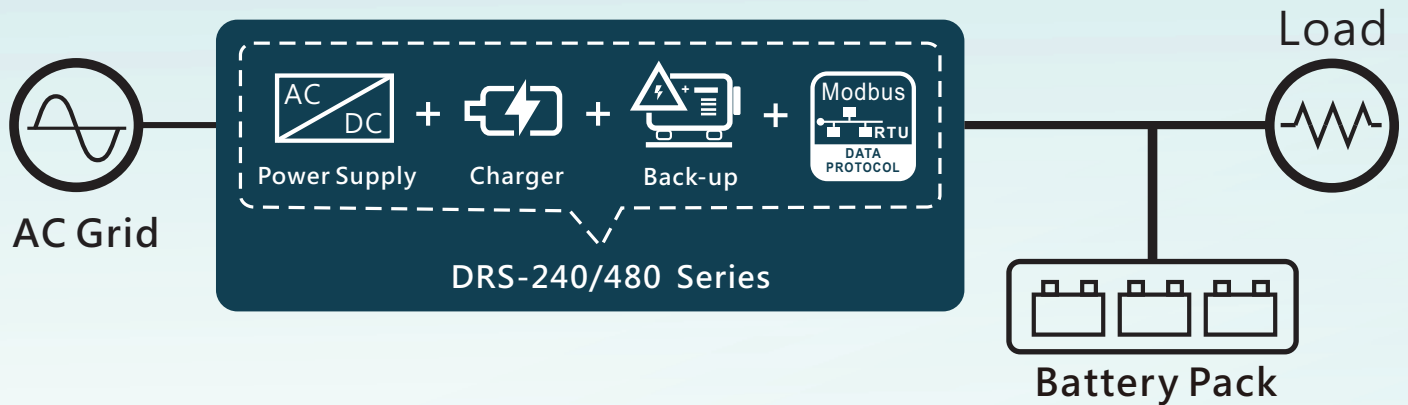

DRS Series User Manual



All-in-one Multi-function Security Power Supply



The DRS series is a DIN-rail type, digital security power supply launched by MEAN WELL. It integrates DC output, battery charge, uninterruptible power source (DC-UPS) and Modbus digital communication in tiny dimensions, thanks to microelectronics. The DRS series accepts the universal input between 90VAC and 305VAC. In addition to the key protection features, such as overload protection, over voltage protection, battery low voltage, disconnect and battery reverse polarity protection. The DRS series also provides Form-C contacts and LED indicators as alarm signals for AC-fail, battery low, charger circuit fail and DC-OK, allowing easy integration into security systems. This series has 2-stage and 3-stage charge curves selectable by DIP switch, charging curves can also be programmed by SBP-001 as well as manual adjustment through a potentiometer (ADJ) on the panel to change charge current from 20% to 100%. The DRS series is suitable for Lead-acid and Lithium batteries with various capacities and can be remotely monitored by communication. The DRS series is a great solution for smart cities and building securities.

Content:

1. Safety Guidelines	1	5.7 Battery start by force button	66
2. Introduction	2	5.8 Battery temperature compensation	67
2.1 Model number	2	5.9 Power boost mode	69
2.2 Features	2	5.10 Restore factory default setting	70
2.3 Main specification	3		
2.4 Safety overview	5	6. Protection and Failure Correction	71
2.5 Derating curve	5	6.1 Protections	71
2.6 Mechanical specification	6	6.2 Failure correction	72
3. Installation & Wiring	8	7. Warranty	73
3.1 Installation methods	8	8. Environmental declaration information	73
3.2 Installation procedures	9		
3.3 Cable selection	9		
3.4 Battery selection	10		
3.5 Serial and parallel connection of battery	10		
4. User Interface Panel	11		
4.1 Panel description	11		
4.2 Pin assignment	12		
4.3 LED indicator	13		
5. Explanation of Setting	14		
5.1 DC voltage supply	14		
5.2 DC-UPS	15		
5.3 Battery charging	15		
5.4 Communication Monitoring function	20		
5.5 Alarm signals	63		
5.6 Battery start by battery start button	66		

1. Safety Guidelines

- Risk of electrical shock and energy hazard. All failure should be examined by a qualified technician. Please do not remove the case of the power supply by yourself.
- Risk of electrical arcs and electric shock (danger to life). Connecting both the primary and the secondary sides together is not allowed.
- Risk of burn hazard. Do not touch the unit in operation and shortly after disconnection.
- Risk of fire and short circuit. The openings should be protected from foreign objects or dripping liquids.
- Only install the unit in a pollution degree 2 environment (Note.1).
- Please do not install the unit in places with high moisture or near the water.
- The FG (⊕) must be connected to PE (Protective Earth).
- Disconnect system from supply voltage:
Before commencing any installation, maintenance or modification work: Disconnect your system from supply voltage. Make sure that inadvertent connection in circuit will be impossible.
- For continued protection against risk of fire, replace only with same type and rating of fuse.
- Notices for battery application
 - a. Make sure charging voltage and current meet battery's specification.
 - b. Refrain from connecting new and old batteries in series.
 - c. The cables between power supply and battery should be kept as short as possible to prevent excessive voltage drop (suggested cable length: 50cm~ 1000cm). Too much voltage drop will lead to longer charging period.
 - d. The power supply is suitable for lead-acid batteries (flooded water type, gel colloid type, AGM adsorption glass fiber) or (lithium ion, lithium manganese, lithium ternary...etc).

Note.1: Pollution Degree 2 applies where there is only non-conductive pollution that might temporarily become conductive due to occasional condensation. Generally refer to dry, well-ventilated locations, such as control cabinets.

2. Introduction

2.1 Model number

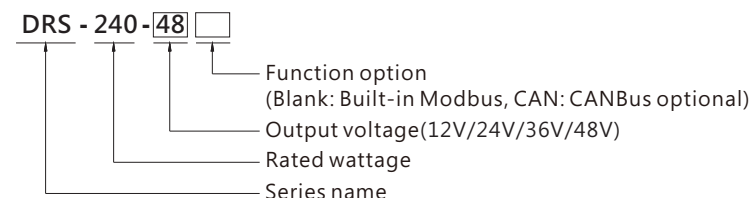

2.2 Features

- All-In-One Intelligent Security Power (Power supply, DC-UPS, battery charger and status monitoring)
- Universal input 90~305Vac with PFC (277Vac available)
- Signal and alarms design meet with UL2524, NFPA 1221, BS EN/EN54-4 and GB17945 requirement
- Priority is given to supplying power to the load to ensure that the equipment can operate normally (remaining power is used to charge the battery)
- Form C relay
- AC fail, DC OK, Low Battery Voltage, Charging fail detection
- Built-in Modbus communication (Optional CANBus)
- Protection: Short circuit/Over voltage/Over load/Over temperature/Battery reverse polarity (No damaged) /Battery under voltage
- Smart programmable charging parameters (with programmer SBP-001)
- 20%~100% charging current adjustable by VR
- 2 or 3-stage selectable by DIP S.W.
- Suitable for lead-acid batteries, such as flooded, Gel, AGM, and so on, or lithium-ion batteries, such as lithium ion, lithium manganese, and so on.
- -30~+70°C wide operating temperature
- LED indicator: status/abnormal indication
- DEKRA/UL/EAC (Pending)/CE/UKCA certified
- 3 years warranty

2.3 Electrical specification

DRS-240 Series

MODEL	DRS-240-12	DRS-240-24	DRS-240-36	DRS-240-48	
OUTPUT	OUTPUT VOLTAGE ^{Note.2}	12V	24V	36V	48V
	CURRENT RANGE	0 ~ 20A	0 ~ 10A	0 ~ 6.6A	0 ~ 5A
	BATTERY CURRENT (CC)(max.)	15.4A	7.7A	5.1A	3.85A
	RECOMMENDED BATTERY CAPACITY(AMP HOURS) ^{Note.3}	20 ~ 200AH	10 ~ 100AH	6.6 ~ 66AH	5 ~ 50AH
	TOTAL OUTPUT POWER ^{Note.4}	Combined power on all Channels must not exceed 240W, load has priority. 275W peak capability within 5s.			
	RIPPLE & NOISE (max.) ^{Note.5}	150mVp-p	240mVp-p	360mVp-p	480mVp-p
	VOLTAGE TOLERANCE ^{Note.6}	±1.0%	±1.0%	±1.0%	±1.0%
	LINE REGULATION	±0.5%	±0.5%	±0.5%	±0.5%
	LOAD REGULATION	±0.5%	±0.5%	±0.5%	±0.5%
	SETUP, RISE TIME ^{Note.7}	2400ms, 1000ms/230VAC 2400ms, 1000ms/115VAC at full load			
HOLD UP TIME (Typ.)	16ms/230VAC 10ms/115VAC at full load				
INPUT	VOLTAGE RANGE	90 ~ 305VAC 127 ~ 431VDC			
	FREQUENCY RANGE	47 ~ 63Hz			
	POWER FACTOR (Typ.)	PF>0.95/230VAC PF>0.98/115VAC at full load			
	EFFICIENCY (Typ.)	90% 92% 92%			
	AC CURRENT (Typ.)	2.8A/115VAC 1.4A/230VAC			
	INRUSH CURRENT (Typ.)	COLD START 30A/115VAC 60A/230VAC			
PROTECTION	SHORT CIRCUIT	Protection type: Constant current limiting, power will shutdown after 5 sec, re-power on to recover.			
	OVERLOAD	105 ~ 135% rated output power Protection type: Constant current limiting, shutdown output voltage after 5 sec.			
	OVER TEMPERATURE	Automatically drop load with temperature only for bat. load. Protection type: Shut down o/p voltage, recover automatically after temperature goes down.			
	OVER VOLTAGE	Load main output: 16.2 ~ 18.6V Load main output: 32.4 ~ 37.3V Load main output: 48.6 ~ 55.9V Load main output: 64.8 ~ 74.5V Protection type: Shut down o/p voltage, re-power on to recover			
	BATTERY CUT OFF	105? 0.3V 209? 0.5V 31.3? 0.7V 41.8? 1V			
	REVERSE POLARITY	By internal MOSFET, no damage, recovers automatically after fault condition is removed.			
	FUNCTION	FORM-C RELAY	AC FAIL	Signals AC failure and activates when input voltage drops below : 79~89VAC of 120AC, 132~187VAC of 220VAC. Relay contact output, ON : AC OK ; OFF : AC Fail ; max. rating : 30Vdc/1A	
CHARGER FAIL			Relay contact output, ON : Charger OK ; OFF : Charger Fail ; max. rating : 30Vdc/1A		
DC OK			Signals normal DC output and activates when output voltage > 90% rated value. Relay contact output, ON : DC OK ; OFF : DC Fail ; max. rating : 30Vdc/1A		
BATTERY LOW/ ABNORMAL/ DISCONNECTED		Relay contact output, ON : Battery OK ; OFF : Battery Low ; max. rating : 30Vdc/1A			
		Battery low voltage:< 11? 0.2V Battery low voltage:< 22? 0.3V Battery low voltage:< 33? 0.4V Battery low voltage:< 44? 0.5V			
BATTERY START		Restart system directly from battery and does not require AC power			
DC-UPS		UPS switch to battery power within 10ms of AC failure			
ADJUSTABLE CHARGING CURRENT		20% ~ 100% charging current adjustable by VR			
BATTERY TEMPERATURE COMPENSATION		The system can change the battery charging voltage by detecting the temperature (Please refer to page 9~10 for more details).			
ENVIRONMENT		WORKING TEMP.	-30 ~ +70 °C (Refer to "Derating Curve")		
	WORKING HUMIDITY	20 ~ 90% RH non-condensing			
	STORAGE TEMP., HUMIDITY	-40 ~ +85 °C, 10 ~ 95% RH non-condensing			
	TEMP. COEFFICIENT	±0.03%/°C (0 ~ 50 °C) on Load output			
	VIBRATION	10 ~ 500Hz, 5G 10min./1cycle, 60min. each along X, Y, Z axes			
	OPERATING ALTITUDE ^{Note.8}	2000 meters / OVC III			
OVER VOLTAGE CATEGORY	III ; According to Dekra BS EN/EN62368-1; altitude up to 2000 meters				
OTHERS	MTBF	564.7K hrs min. Telcordia SR-332 (Bellcore); 73.3K hrs min. MIL-HDBK-217F (25 °C)			
	DIMENSION	85.5*125.2*129.2mm (W*H*D)			
	PACKING	1.19Kg; 8pcs/ 12.5Kg / 1.08CUFT			

DRS-480 Series

MODEL	DRS-480-24	DRS-480-36	DRS-480-48	
OUTPUT	OUTPUT VOLTAGE ^{Note.2}	24V	36V	48V
	LOAD CURRENT RANGE	0 ~ 20A	0 ~ 13.3A	0 ~ 10A
	BATTERY CURRENT (CC)(max.)	15.4A	10.2A	7.7A
	RECOMMENDED BATTERY CAPACITY(AMP HOURS) ^{Note.3}	20 ~ 200AH	13 ~ 133AH	10 ~ 100AH
	TOTAL OUTPUT POWER ^{Note.4}	Combined power on all Channels must not exceed 480W, load has priority. 550W peak capability within 5s.		
	RIPPLE & NOISE (max.) ^{Note.5}	240mVp-p	360mVp-p	480mVp-p
	VOLTAGE TOLERANCE ^{Note.6}	±1.0%	±1.0%	±1.0%
	LINE REGULATION	±0.5%	±0.5%	±0.5%
	LOAD REGULATION	±0.5%	±0.5%	±0.5%
	SETUP, RISE TIME ^{Note.7}	2400ms, 1000ms/230VAC 2400ms, 1000ms/115VAC at full load		
HOLD UP TIME (Typ.)	16ms/230VAC 10ms/115VAC at full load			
INPUT	VOLTAGE RANGE	90 ~ 305VAC 127 ~ 431VDC		
	FREQUENCY RANGE	47 ~ 63Hz		
	POWER FACTOR (Typ.)	PF>0.95/230VAC PF>0.98/115VAC at full load		
	EFFICIENCY (Typ.)	92.5% 93.5%		
	AC CURRENT (Typ.)	5.4A/115VAC 2.7A/230VAC		
	INRUSH CURRENT (Typ.)	COLD START 30A/115VAC 60A/230VAC		
PROTECTION	SHORT CIRCUIT	Protection type: Constant current limiting, power will shutdown after 5 sec, re-power on to recover.		
	OVERLOAD	105 ~ 135% rated output power Protection type: Constant current limiting, shutdown output voltage after 5 sec.		
	OVER TEMPERATURE	Automatically drop load with temperature only for bat. load. Protection type: Shut down o/p voltage, recover automatically after temperature goes down.		
	OVER VOLTAGE	Load main output: 32.4 ~ 37.3V Load main output: 48.6 ~ 55.9V Load main output: 64.8 ~ 74.5V Protection type: Shut down o/p voltage, re-power on to recover		
	BATTERY CUT OFF	20.9? 0.5V 31.3? 0.7V 41.8? 1V		
	REVERSE POLARITY	By internal MOSFET, no damage, recovers automatically after fault condition is removed.		
	FUNCTION	FORM-C RELAY	AC FAIL	Signals AC failure and activates when input voltage drops below : 79~89VAC of 120AC, 132~187VAC of 220VAC. Relay contact output, ON : AC OK ; OFF : AC Fail ; max. rating : 30Vdc/1A
CHARGER FAIL			Relay contact output, ON : Charger OK ; OFF : Charger Fail ; max. rating : 30Vdc/1A	
DC OK			Signals normal DC output and activates when output voltage > 90% rated value. Relay contact output, ON : DC OK ; OFF : DC Fail ; max. rating : 30Vdc/1A	
BATTERY LOW/ ABNORMAL/ DISCONNECTED		Relay contact output, ON : Battery OK ; OFF : Battery Low ; max. rating : 30Vdc/1A		
		Battery low voltage : < 22V? 0.3V Battery low voltage : < 33V? 0.4V Battery low voltage : < 44V? 0.5V		
BATTERY START		Restart system directly from battery and does not require AC power		
DC-UPS		UPS switch to battery power within 10ms of AC failure		
ADJUSTABLE CHARGING CURRENT		20% ~ 100% charging current adjustable by VR		
BATTERY TEMPERATURE COMPENSATION		The system can change the battery charging voltage by detecting the temperature (Please refer to page 9~10 for more details).		
ENVIRONMENT		WORKING TEMP.	-30 ~ +70 °C (Refer to "Derating Curve")	
	WORKING HUMIDITY	20 ~ 90% RH non-condensing		
	STORAGE TEMP., HUMIDITY	-40 ~ +85 °C, 10 ~ 95% RH non-condensing		
	TEMP. COEFFICIENT	±0.03%/°C (0 ~ 50 °C) on Load output		
	VIBRATION	10 ~ 500Hz, 5G 10min./1cycle, 60min. each along X, Y, Z axes		
	OPERATING ALTITUDE ^{Note.8}	2000 meters / OVC III		
OVER VOLTAGE CATEGORY	III ; According to Dekra BS EN/EN62368-1; altitude up to 2000 meters			
OTHERS	MTBF	556.6K hrs min. Telcordia SR-332 (Bellcore); 74.5K hrs min. MIL-HDBK-217F (25 °C)		
	DIMENSION	110*125.2*150.7mm (W*H*D)		
	PACKING	1.65Kg; 6pcs/ 11Kg / 1.42CUFT		

2.4 Safety Overview



2.5 Derating Curve

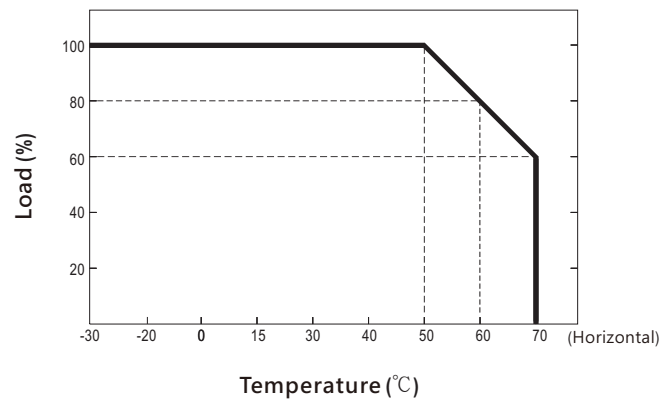

2.6 Mechanical Specification

(DRS-240 Series)

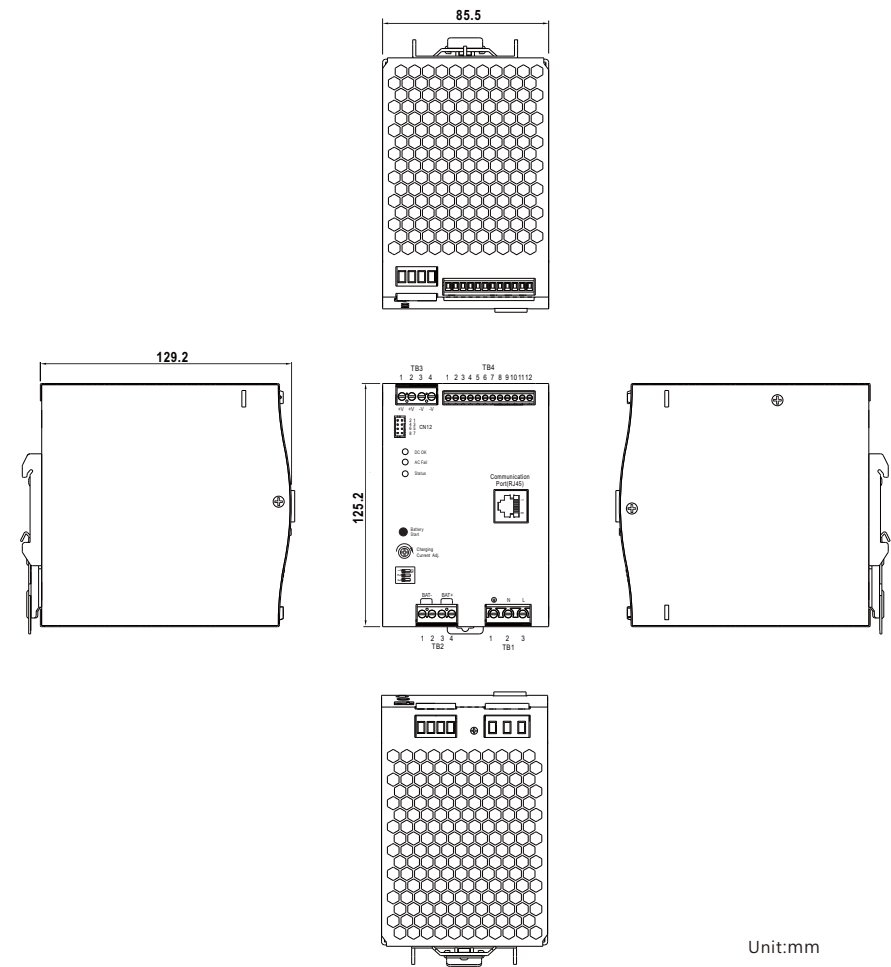

(DRS-480 Series)

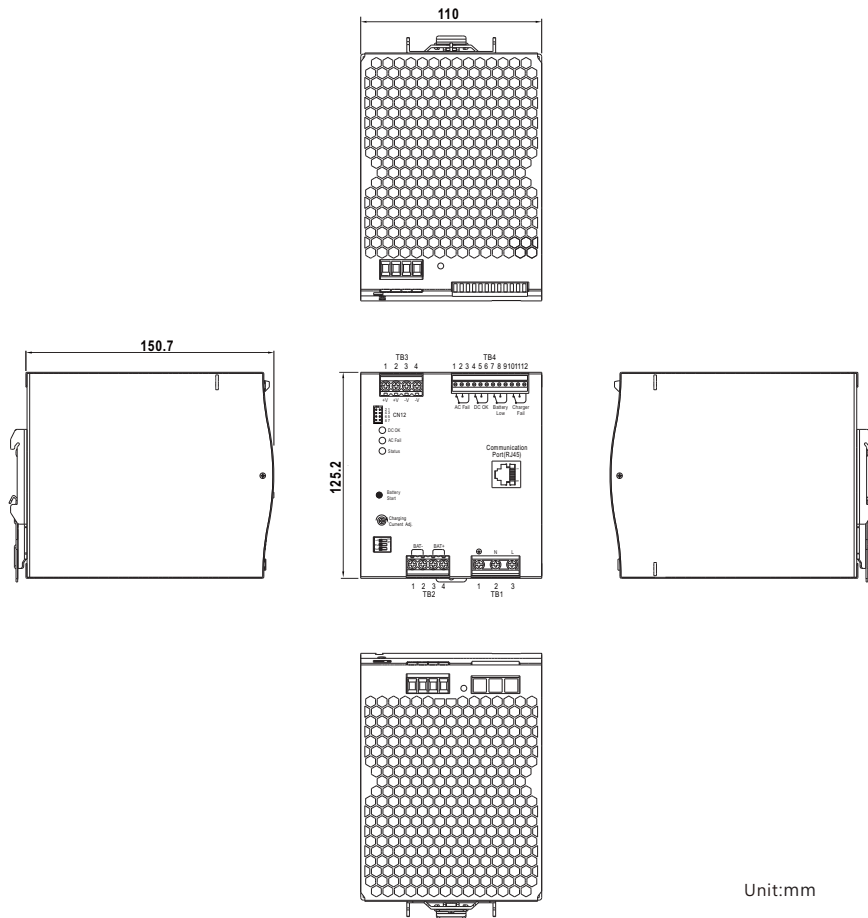

3. Installation & Wiring

3.1 Installation methods

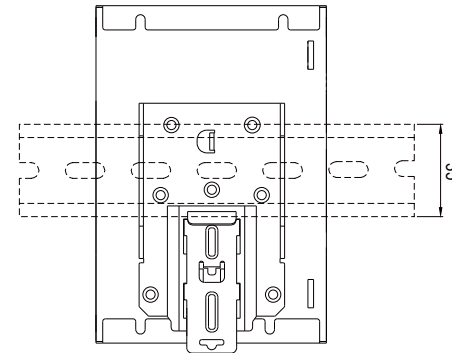

Admissible DIN rail: TS35/7.5或TS35/15
(only for reference, not included in shipment)

- ① Tilt the unit slightly rearwards
- ② Fit the unit over top hat rail
- ③ Slide it downward until it hits the stop
- ④ Press against the bottom for locking
- ⑤ Shake the unit slightly to check the locking action

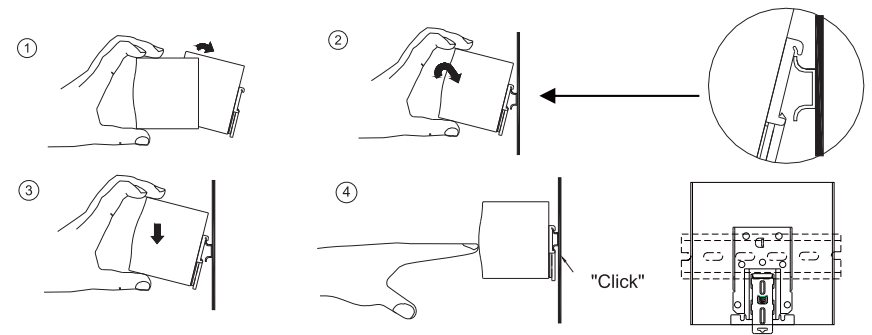

3.2 Installation procedures

Step 1. Please connect AC input cables, DC output cables, battery charging cables, and RJ-45 communication cables(if used) to the terminal blocks of this product.



Step 2. Make sure all cables are well connected, then feeds the AC energy to the supply.

Step 3. After power-on, make sure LED indicates in green or orange, meaning normal operation. (LED status refer to Chapter 4.3)

3.3 Cable selection

Wire connections should be as short as possible. Make sure that suitable wires are chosen based on safety requirement and rating of current. Small cross section will result in lower efficiency, less output power and the wires may also become overheated and cause danger. For selection, please refer to the following table.

AWG	Cross-section Area (mm ²)	Max.Current(A)UL1015(600V 105°C)
18	0.8	6
16	1.3	8
14	2.1	12
12	3.3	22
10	5.3	35
7	10	46
6	16	60
4	25	80
2	43	110

Recommendations for the use of wires

3.4 Battery selection

Battery types: Lead acid or lithium ion batteries

Battery capacity: Please refer to the following table

Models	Battery capacity recommendation			
	12V	24V	36V	48V
DRS-240	20~200AH or above	10~ 100AH or above	6.6~66AH or above	5~ 50AH or above
DRS-480	/	20~200AH or above	13~133AH or above	10~100AH or above

NOTE:

- Using batteries with greater capacity than recommendation will not damage the battery, but extend charging period is expected.
- Please contact battery supplier for charging characteristics if it's not clear.

3.5 Serial and parallel connection of battery

- Serial connection: When connect 2 batteries in series, it doubled the output voltage, but the capacity remains.

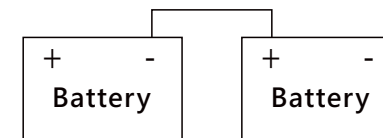

EX: 2pcs of 12V 100AH in series, become a 24V 100AH battery.

- Parallel connection: When 2 batteries connected in parallel, output voltage remains, but the capacity becomes doubled.

EX: 2pcs of 12V 100AH connect in parallel, become a 12V 200AH battery.

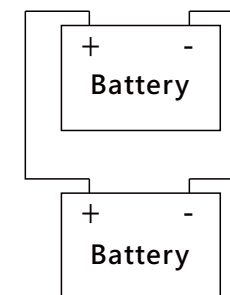

4. User Interface Panel

4.1 Panel description

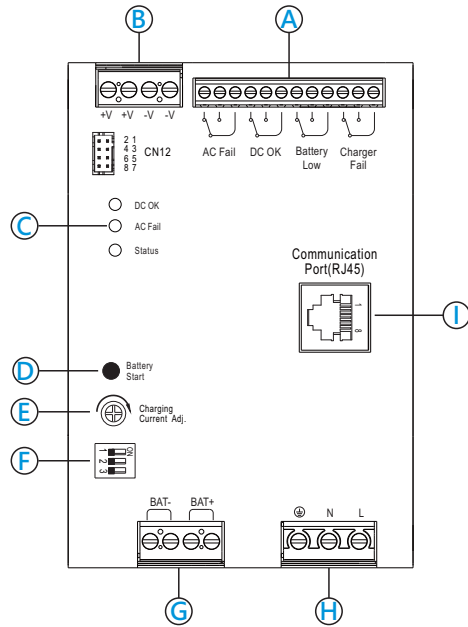

- A** Alarm signal:
It is used for monitoring function. Please refer to chapter 4.2
- B** Terminals of DC output
- C** LED indicators: To show the status of unit.
- D** Battery start button:
Restart system directly from battery and does not require AC power
- E** Io ADJ:
For charging current setting (depend on battery capacity)
- F** Charging curve setting

1	OFF:3-stage (default), ON:2-stage
2	Charging curve setting
3	

Please refer to chapter 5.3.4.1
- G** Terminals of battery connection
- H** Terminals of AC input
- I** For Modbus communication

Cable selection and suggested torque:

Terminals	Input (G)		Output (A)		Battery (F)		Control pin (C)	
	Wire	Suggested Torque	Wire	Suggested Torque	Wire	Suggested Torque	Wire	Suggested Torque
DRS-240	12-26AWG	5Kgf-cm	12-24AWG	5.7Kgf-cm	12-24AWG	5.7Kgf-cm	14-30AWG	2Kgf-cm
DRS-480	10-22AWG	10Kgf-cm	10-22AWG	8Kgf-cm	10-22AWG	8Kgf-cm	16-26AWG	2Kgf-cm

4.2 Pin assignment

PIN definition of CN12: JS-2008R-4*2-T or equivalent

Pin	Function	Description	Connector
1	3.3V	+3.3V for programmer	
2	GND	Reference ground of communication	
3	RTH+	NTC connection	
4	RTH-		
5	A0	Address line(A1), reference to PIN2GND(Signal)	
6	A1	Address line(A0), reference to PIN2GND(Signal)	
7,8	Open: Normal Short: Force	Force start UPS function	

Terminal Pin No. Assignment (TB4)

Pin	Function	Description	Terminal
1,2,3	AC fail	Refer to chapter 5.5.1	
4,5,6	DC OK	Refer to chapter 5.5.2	
7,8,9	Battery low/ Abnormal/ Disconnected	Refer to chapter 5.5.3	
10,11,12	Charger fail	Refer to chapter 5.5.4	

Terminal Pin No. Assignment (RJ-45)

Pin	Function	Description	Rj45
1,2,3,4,5	NC	No connection	
6	DB/D-	Modbus mode: Communication via Modbus	
7	CANH	CANBus mode: Communication via CANBus	
	DA/D+	Modbus mode: Communication via Modbus	
8	CANL	CANBus mode: Communication via CANBus	
	GND-AUX	Reference GND of AUX and is isolated from the output terminal. (+V & -V)	

4.3 LED indicator

Indicator	Description	LED indicator	
DC OK	DC fail	OFF	
	DC OK	Green	
AC fail	AC fail	Red	
	AC OK	OFF	
Status	Charging status	Float	Green
		Charging: CC/CV	Red
	System Diagnostic	Discharging	Orange: 1Blink/Pause
		Charger fail	Red: 1Blink/Pause
		Battery overvoltage/ Battery reverse polarity	Red: 2Blink/Pause
		Battery low/ No battery	Red: 3Blink/Pause
		Battery discharging peak power over timeout	Red: 4Blink/Pause
		Over load/ Short	Red: 5Blink/Pause
		Over temperature	Red: 6Blink/Pause
		Timeout	Red: 7Blink/Pause

5. Explanation of Setting

DRS series integrates multi-functions in tiny dimension, including DC output power, battery charging, DC-UPS and communication monitoring. Alarm signals, AC Fail, DC OK, battery under voltage/disconnection, charger Fail, and 2-stage or 3-stage battery charging, programmable rating of charging current from 20% to 100%, temperature compensation, etc.

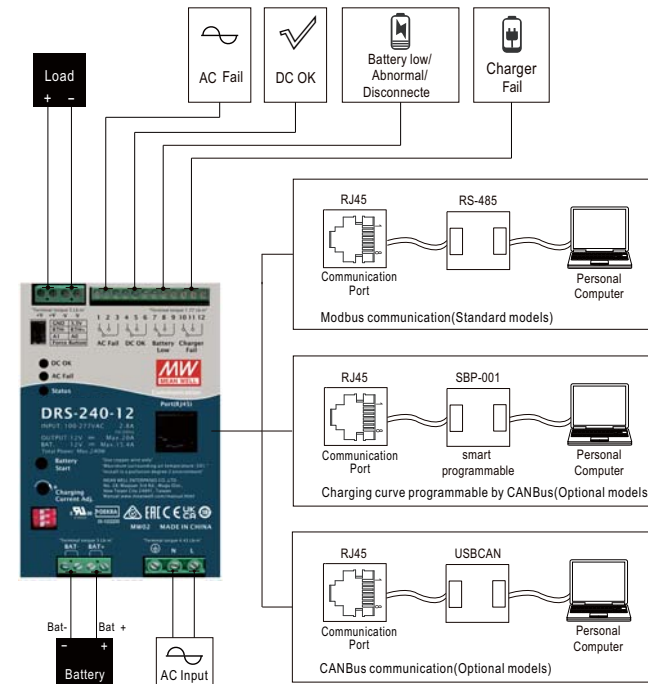

5.1 DC voltage supply

When power on, power supply will provide DC voltage to load first and then battery. It automatically reduces charging current to improve system stability.

5.2 DC-UPS

5.2.1. When AC mains drops below:79~89VAC of 120VAC, 132~187VAC of 220VAC, UPS function will activate and power source switch battery backup.

Note: From AC to battery, switch period is within 10ms.

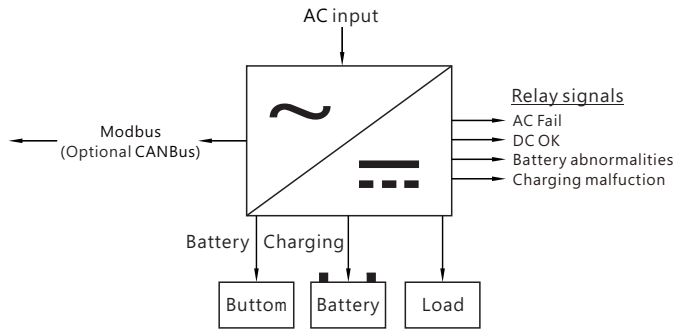

5.2.2. Back-up time

Back-up time depends on : ※ Load current
 ※ Battery capacity

Example: (C10 discharging)

Battery Load	10AH	20AH	50AH	100AH	200AH
1.5A	350min	13h	33h	67h	133h
3A	125min	350min	17h	33h	67h
5A	60min	180min	600min	20h	40h
7.5A	35min	90min	350min	13h	27h
10A	23min	60min	240min	10h	20h
15A	13min	35min	125min	350min	13h

5.3 Battery charging

DIP switch on the panel is used for charging curve selection, 2-stage or 3-stage. 2-stage including C.C and C.V is simple fast charging. 3-stage including C.C, C.V and F.V will not turn off after 2-stage of charging finished. Users can choose between 2- or 3-stage according to the demand.

Note: DC UPS function will not be achieve in 5 seconds at first start-up.

5.3.1 2-stage charging (DIP switch on "2" stage)



In the initial stage of charging, the charger charges the battery with the maximum current, and the fan is ON (built-in fan model). After a period of time (depending on the battery capacity), the charging current gradually decreases. When the charging current drops to 10% of the rated current, LED indicator lights up in green, indicating that the charging process is complete. If the charging is finished, power supply will turn off the output of charger, but remains the output of load.

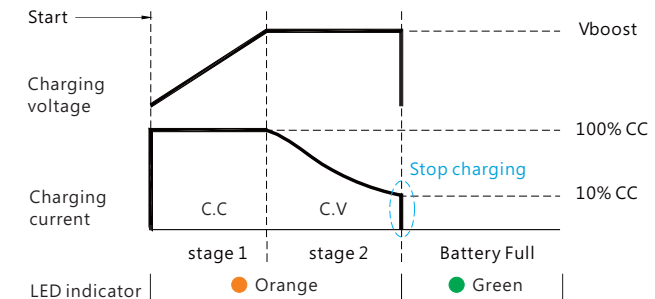

Status	DRS-240-12	DRS-240-24	DRS-240-36	DRS-240-48
C.C	15.4A	7.7A	5.1A	3.85A
Vboost	14.4V	28.8V	43.2V	57.6V

Status	DRS-480-24	DRS-480-36	DRS-480-48
C.C	15.4A	10.2A	7.7A
Vboost	28.8V	43.2V	57.6V

5.3.2 3-stage charging (DIP switch on "3" stage)



In the initial stage of charging, the charger charges the battery with the maximum current. After a period (depending on the battery capacity), the charging current gradually decreases. When the charging current drops to 10% of the rated current. LED indicator lights up in green, indicating that the charging is complete and the charger remains float charging stage.

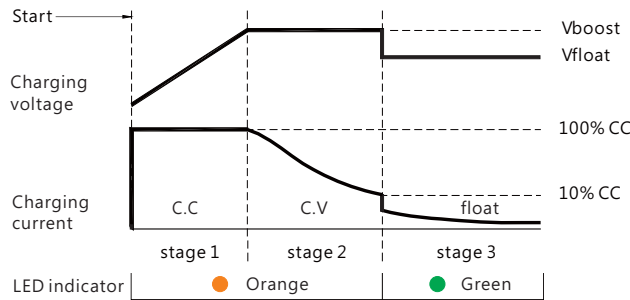

Status	DRS-240-12	DRS-240-24	DRS-240-36	DRS-240-48
C.C	15.4A	7.7A	5.1A	3.85A
Vboost	14.4V	28.8V	43.2V	57.6V
Vfloat	13.8V	27.6V	41.4V	55.2V

Status	DRS-480-24	DRS-480-36	DRS-480-48
C.C	15.4A	10.2A	7.7A
Vboost	28.8V	43.2V	57.6V
Vfloat	27.6V	41.4V	55.2V

5.3.3 Charging current adjustment

Charging current can be adjusted by the SVR on the panel from 20% to 100% rated charging current.



5.3.4 Charging curve setting

5.3.4.1 Explanation of DIP switch

The charging curve can be adjusted through the DIP switch on the panel. By following the chart below, there are both 2 and 3 stage charging curves that can be chosen accordingly.

1	OFF:3-stage (default) , ON:2-stage	
2	Refer to the following table	
3		

Built-in 2-stage charging curves

DRS-240

DIP SW		12V model			
2	3	Description	CC(default)	Vboost	Vfloat
OFF	OFF	Default, programmable	15.4A	14.4	13.8
ON	OFF	Pre-defined, Gel battery		14.0	13.6
OFF	ON	Pre-defined, flooded		14.2	13.4
ON	ON	Pre-defined, AGM and LiFeO4		14.6	14.0

DIP SW		24V model			
2	3	Description	CC(default)	Vboost	Vfloat
OFF	OFF	Default, programmable	7.7A	28.8	27.6
ON	OFF	Pre-defined, Gel battery		28.0	27.2
OFF	ON	Pre-defined, flooded		28.4	26.8
ON	ON	Pre-defined, AGM and LiFeO4		29.2	28.0

DIP SW		36V model			
2	3	Description	CC(default)	Vboost	Vfloat
OFF	OFF	Default, programmable	5.1A	43.2	41.4
ON	OFF	Pre-defined, Gel battery		42	40.8
OFF	ON	Pre-defined, flooded		42.6	40.2
ON	ON	Pre-defined, AGM and LiFeO4		43.8	42.0

DIP SW		48V model			
2	3	Description	CC(default)	Vboost	Vfloat
OFF	OFF	Default, programmable	3.85A	57.6	55.2
ON	OFF	Pre-defined, Gel battery		56.0	54.4
OFF	ON	Pre-defined, flooded		56.8	53.6
ON	ON	Pre-defined, AGM and LiFeO4		58.4	56.0

Built-in 3-stage charging curve

DRS-240

DIP SW		12V model					
2	3	Description	CC(default)	Vboost	Vfloat	Vfloat	Vfloat
OFF	OFF	Default, programmable	15.4A	14.4	13.8	13.8	13.8
ON	OFF	Pre-defined, Gel battery		14.0	13.6	13.6	13.6
OFF	ON	Pre-defined, flooded		14.2	13.4	13.4	13.4
ON	ON	Pre-defined, AGM and LiFeO4		14.6	14.0	14.0	14.0

DIP SW		24V model					
2	3	Description	CC(default)	Vboost	Vfloat	Vfloat	Vfloat
OFF	OFF	Default, programmable	7.7A	28.8	27.6	27.6	27.6
ON	OFF	Pre-defined, Gel battery		28.0	27.2	27.2	27.2
OFF	ON	Pre-defined, flooded		28.4	26.8	26.8	26.8
ON	ON	Pre-defined, AGM and LiFeO4		29.2	28.0	28.0	28.0

DIP SW		36V model					
2	3	Description	CC(default)	Vboost	Vfloat	Vfloat	Vfloat
OFF	OFF	Default, programmable	5.1A	43.2	41.4	41.4	41.4
ON	OFF	Pre-defined, Gel battery		42	40.8	40.8	40.8
OFF	ON	Pre-defined, flooded		42.6	40.2	40.2	40.2
ON	ON	Pre-defined, AGM and LiFeO4		43.8	42.0	42.0	42.0

DIP SW		48V model					
2	3	Description	CC(default)	Vboost	Vfloat	Vfloat	Vfloat
OFF	OFF	Default, programmable	3.85A	57.6	55.2	55.2	55.2
ON	OFF	Pre-defined, Gel battery		56.0	54.4	54.4	54.4
OFF	ON	Pre-defined, flooded		56.8	53.6	53.6	53.6
ON	ON	Pre-defined, AGM and LiFeO4		58.4	56.0	56.0	56.0

DRS-480

DIP SW		24V model			
2	3	Description	CC(default)	Vboost	Vfloat
OFF	OFF	Default, programmable	15.4A	28.8	27.6
ON	OFF	Pre-defined, Gel battery		28.0	27.2
OFF	ON	Pre-defined, flooded		28.4	26.8
ON	ON	Pre-defined, AGM and LiFeO4		29.2	28.0

DIP SW		36V model			
2	3	Description	CC(default)	Vboost	Vfloat
OFF	OFF	Default, programmable	10.2A	43.2	41.4
ON	OFF	Pre-defined, Gel battery		42	40.8
OFF	ON	Pre-defined, flooded		42.6	40.2
ON	ON	Pre-defined, AGM and LiFeO4		43.8	42.0

DIP SW		48V model			
2	3	Description	CC(default)	Vboost	Vfloat
OFF	OFF	Default, programmable	7.7A	57.6	55.2
ON	OFF	Pre-defined, Gel battery		56.0	54.4
OFF	ON	Pre-defined, flooded		56.8	53.6
ON	ON	Pre-defined, AGM and LiFeO4		58.4	56.0

NOTE: Voltage tolerance of $\pm 2\%$

DRS-480

DIP SW		24V model					
2	3	Description	CC(default)	Vboost	Vfloat	Vfloat	Vfloat
OFF	OFF	Default, programmable	15.4A	28.8	27.6	27.6	27.6
ON	OFF	Pre-defined, Gel battery		28.0	27.2	27.2	27.2
OFF	ON	Pre-defined, flooded		28.4	26.8	26.8	26.8
ON	ON	Pre-defined, AGM and LiFeO4		29.2	28.0	28.0	28.0

DIP SW		36V model					
2	3	Description	CC(default)	Vboost	Vfloat	Vfloat	Vfloat
OFF	OFF	Default, programmable	10.2A	43.2	41.4	41.4	41.4
ON	OFF	Pre-defined, Gel battery		42	40.8	40.8	40.8
OFF	ON	Pre-defined, flooded		42.6	40.2	40.2	40.2
ON	ON	Pre-defined, AGM and LiFeO4		43.8	42.0	42.0	42.0

DIP SW		48V model					
2	3	Description	CC(default)	Vboost	Vfloat	Vfloat	Vfloat
OFF	OFF	Default, programmable	7.7A	57.6	55.2	55.2	55.2
ON	OFF	Pre-defined, Gel battery		56.0	54.4	54.4	54.4
OFF	ON	Pre-defined, flooded		56.8	53.6	53.6	53.6
ON	ON	Pre-defined, AGM and LiFeO4		58.4	56.0	56.0	56.0

NOTE: Voltage tolerance of $\pm 2\%$

5.3.4.2 Setting by communication

Users can set charging parameters via Modbus or CANBus(optional) including constant current, voltage, float voltage, taper current, battery temperature compensation and charge time, etc. Refer to chapter 5.4 for details.

5.3.4.3 Smart charging curve programming by SBP-001 (only for CANBus models)

SBP- 001 is a smart battery charging programmer developed by MEAN WELL, which can set the charging curves of the DRS series through editing software. SBP-001 provides functions such as charging curve adjustment and battery temperature compensation. Please set the DIP switch pin to Default, programmable (PIN2: OFF; PIN3 : OFF) before use. Configuration and software interface are shown as below. Please refer to “SBP-001 Smart Battery Charging Programmer User Manual” for details.

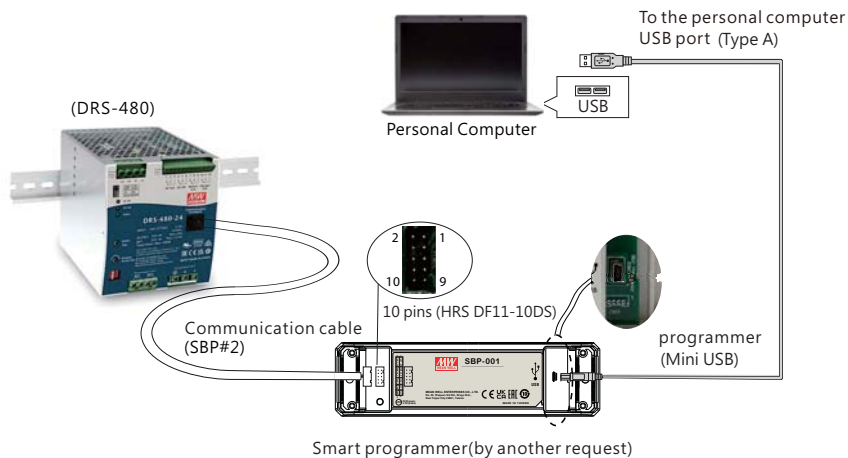

Programmable charging curve

Model selection

Time out

5.4 Communication monitoring function

5.4.1 Modbus communication

The Modbus protocol can be used to read status and control settings of the all-in-on security powers (slave), including operation on/off, output voltage/current adjustment and internal temperature reading. In addition, charge curves and relative charge parameters of constant current, constant voltage, float voltage, taper current, battery temperature compensation and charge time. Output can also be adjusted when set in the charge mode.

5.4.1.1 Modbus specifications

Modbus communication interface

This device supports Modbus RTU with the master-slave principle. During data transfer, please follow the principle of first sending the High byte and then the Low byte except Error Check(CRC-16 checksum).

Physical Layer setting as below:

Control	Setting
Baud Rate	115200
Data Bits	8
Stop Bits	1
Parity	None
Flow Control	None

5.4.1.2 Communication interface

- Min. request period (Controller to PSU/CHG): 50mSec ◦
- Max. response time (PSU/CHG to Controller): 12.5mSec ◦
- Min. packet margin time (Controller to PSU/CHG): 12.5mSec ◦

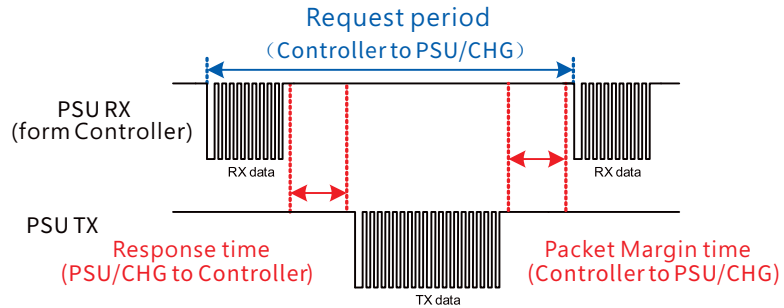

5.4.1.3 Modbus frame encapsulation

Modbus RTU consists of Additional Address, Function Code, Data and Error Check.

Additional address	Function code	Data	Error check
1 byte	1 byte	N bytes	2 bytes

- Additional address (1byte): defines PSU slave ID
- Function code (1byte): The function code is used to tell the slave what kind of action to perform.
- Data (N bytes): For data exchange, contents and data length are dependent on different function codes.
- Error Check (2bytes): utilizes CRC-16.

5.4.1.4 Additional address definition

Additional address is the slave ID of the device. Each DRS unit should have their unique and own device address to communicate over the bus. Slave ID is set by CN12 (A0~A1)
The device address is set as follows:

Between A0/A1 and GND (Single)	logic
Open	1
Short	0

Device No.	Device address	
	A1	A0
0	0	0
1	0	1
2	1	0
3	1	1

Slave ID	Description
0x8X	X means device address
0x00	Broadcast

Note: Broadcast is only for command write but not read.

5.4.1.5 Function code description

The main purpose of the function codes is to tell the slave what kind of action to perform. For example, function code 03 will query the slave to read holding registers and respond the master server with their contents.

Function Code of DRS as follow :

Function Code	Description
Read Holding Register	0x03
Read Input Register	0x04
Preset Single Register	0x06

5.4.1.6 Data field and command lists

Data field provides additional information by the slave to complete the action specified by the function code in a request. The data field typically includes register addresses, count values, and written data. There are two forms according to the function codes.

FC=03/04

Starting Address	Quantity of (Input) Registers
2 Bytes	2 Bytes

FC=06

Register Addressr	Register Value
2 Bytes	2 Bytes

The following is data description of register addresses.

Register address	# of data Bytes	Command Name	Description	Function code	Value	unit
0x0000	2	OPERATION	Remote ON/OFF control	0x03 ∖ 0x06	0x00(OFF)/0x01(ON)	-
0x0020	2	VOUT_SET	Output voltage set	0x03 ∖ 0x06	Refer to 5.4.4	V
0x0040	2	FAULT_STATUS	Abnormal status	0x03	Refer to transmission data description	-
0x0050	2	READ_VIN	Input voltage read value	0x04	Refer to 5.4.4	V
0x0060	2	READ_VOUT	Output voltage	0x04	Refer to 5.4.4	V
0x0061	2	READ_IOUT	Output current	0x04	Refer to 5.4.4	A
0x0062	2	READ_TEMPERATURE_1	Internal ambient	0x04	Refer to 5.4.4	°C
0x0080~0x0082	6	MFR_ID_B0B5	Manufacture's name	0x03	Refer to transmission data description	ASCII
0x0083~0x0085	6	MFR_ID_B6B11	Manufacture's name	0x03	Refer to transmission data description	ASCII
0x0086~0x0088	6	MFR_MODEL_B0B5	Manufacture model name	0x03	Refer to transmission data description	ASCII
0x0089~0x008B	6	MFR_MODEL_B6B11	Manufacture model name	0x03	Refer to transmission data description	ASCII
0x008C~0x008E	6	MFR_REVISION_B0B5	Firmware version	0x03	Refer to transmission data description	Binary
0x008F~0x0090	4	MFR_LOCATION_B0B2	Manufacture place	0x03 ∖ 0x06	TWN/CHN	ASCII
0x0091~0x0093	6	MFR_DATE_B0B5	Manufacture date	0x03 ∖ 0x06	Refer to transmission data description	ASCII
0x0094~0x0096	6	MFR_SERIAL_B0B5	Manufacture serial number	0x03 ∖ 0x06	Refer to transmission data description	ASCII
0x0097~0x0099	6	MFR_SERIAL_B6B11	Manufacture serial number	0x03 ∖ 0x06	Refer to transmission data description	ASCII
0x00B0	2	CURVE_CC	Constant current setting (only for charger)	0x03 ∖ 0x06	Refer to 5.4.4	A
0x00B1	2	CURVE_CV	Constant voltage setting (only for charger)	0x03 ∖ 0x06	Refer to 5.4.4	V
0x00B2	2	CURVE_FV	Floating voltage setting (only for charger)	0x03 ∖ 0x06	Refer to 5.4.4	V
0x00B3	2	CURVE_TC	Taper current setting (only for charger)	0x03 ∖ 0x06	Refer to 5.4.4	A

0x00B4	2	CURVE_CONFIG	Configuration setting (only for charger)	0x03 ∖ 0x06	Refer to transmission data description	-
0x00B5	2	CURVE_CC_TIMEOUT	CC charge timeout setting (only for charger)	0x03 ∖ 0x06	Refer to 5.4.4	Min
0x00B6	2	CURVE_CV_TIMEOUT	CV charge timeout setting	0x03 ∖ 0x06	Refer to 5.4.4	Min
0x00B7	2	CURVE_FV_TIMEOUT	FV charge timeout setting (only for charger)	0x03 ∖ 0x06	Refer to 5.4.4	Min
0x00B8	2	CHG_STATUS	Charging status reporting (only for charger)	0x03	Refer to transmission data description	-
0x00C0~0x00C2	6	SCALING_FACTOR	Scaling ratio	0x03	Refer to transmission data description	-
0x00C3	2	SYSTEM_STATUS	System status	0x03	Refer to transmission data description	-
0x00C4	2	SYSTEM_CONFIG	System configuration	0x03 ∖ 0x06	Refer to transmission data description	-
0x00D0	2	BAT_UVP_SET	BAT_LOW protect setting	0x03 ∖ 0x06	Refer to 5.4.4	V
0x00D1	2	Force_BAT_UVP_SET	Force BAT_LOW protect setting	0x03 ∖ 0x06	Refer to 5.4.4	V
0x00D2	2	UPS_CONFIG	UPS config setting	0x03 ∖ 0x06	Refer to transmission data description	-
0x00D3	2	READ_VBAT	Voltage of battery	0x04	Refer to 5.4.4	V
0x00D4	2	READ_IBAT	Charging or discharging current of battery	0x04	Refer to 5.4.4	A
0x00D5	2	READ_BAT_TEMPERATURE	Temperature of battery	0x04	Refer to 5.4.4	°C
0x00E0	2	AC_Fail_LL_SET	AC fail low line point setting	0x03 ∖ 0x06	Refer to 5.4.4	V
0x00E1	2	AC_Fail_HL_SET	AC fail high line point setting	0x03 ∖ 0x06	Refer to 5.4.4	V
0x00E2	2	AC_OK_LL_SET	AC OK low line point setting	0x03 ∖ 0x06	Refer to 5.4.4	V
0x00E3	2	AC_OK_HL_SET	AC OK high line point setting	0x03 ∖ 0x06	Refer to 5.4.4	V
0x00E4	2	TIME_BUFFERING	Buffering time setting	0x03 ∖ 0x06	Refer to 5.4.4	Min
0x00E8	2	UPS_Delay_Time	UPS shutdown delay time setting	0x03 ∖ 0x06	Refer to 5.4.4	Sec
0x00E9	2	UPS_Shutdown_Time	UPS shutdown time setting	0x03 ∖ 0x06	Refer to 5.4.4	Sec

Note: 1. The Time_Buffering setting takes effect only when the bit2 of the low bytes of UPS_CONFIG(0x00D2)=1.
 2. The UPS_Delay_Time setting takes effect only when the bit 4 of the low byte of UPS_CONFIG (0x00D2) is 1.
 3. The UPS_Shutdown_Time setting takes effect only when the bit 5 of the low byte of UPS_CONFIG (0x00D2) is 1.

Transmission data description:

The conversion of setting and reading values is defined as following:

Actual value= Communication reading value ×F actor (F value).

Among them Factor needs to refer to the definition of SCALING_FACTOR in each model list.

EX: Vo_real(actual DC voltage)= READ_VOUT ×F actor.

If the Factor of READ_VOUT of a certain model is 0.01, the communication reading value is 0x0960(hexadecimal)→2400(decimal), then Vo_real = 2400 ×0 .01 = 24.00V.

◎ **FAULT_STATUS(0x0040) :**

	Bit7	Bit6	Bit5	Bit4	Bit3	Bit2	Bit1	Bit0
High byte	Reserved	Reserved	Reserved	Reserved	Reserved	Reserved	Reserved	Reserved
Lowbyte	HI_TEMP	OP_OFF	AC_FAIL	SHORT	OLP	OVP	OTP	FAN_FAIL

Low byte

Bit 0 FAN_FAIL: Fan abnormal state (Not support)

0 = Normal state

1 = abnormal state

Bit 1 OTP: Over temperature protection

0 = Normal internal temperature

1 = Abnormal internal temperature

Bit 2 OVP: Output over-voltage protection

0 = Normal output voltage

1 = Abnormal output voltage

Bit 3 OLP: Output over current protection

0 = Normal output current

1 = Abnormal output current

Bit 4 SHORT: Short circuit protection

0 = Shorted circuit does not exist

1 = Shorted circuit protected

Bit 5 AC_FAIL: AC abnormal flag

0 = Normal AC range

1 = Abnormal AC range

Bit 6 OP_OFF: DC status

0 = DC turned on

1 = DC turned off

Bit 7 HI_TEMP: High ambient temperature protection

0 = Normal ambient temperature

1 = Abnormal ambient temperature

High byte: Bit 0:7

Reserved: Currently not in use, retain (default is 0)

Note: Unsupported settings displays with "0"

◎ **MFR_ID_B0B5(0x0080-0x0082)** is the first 6 codes of the manufacturer's name (ASCII);

MFR_ID_B6B11(0x0083-0x0085) is the last 6 codes of the manufacturer's name (ASCII)

EX: manufacturer's name is MEANWELL→MFR_ID_B0B5 is MEANWE;

MFR_ID_B6B11 is LL

MFR_ID_B0B5					
Byte 0	Byte 1	Byte 2	Byte 3	Byte 4	Byte 5
0x4D	0x45	0x41	0x4E	0x57	0x45

MFR_ID_B6B11					
Byte 0	Byte 1	Byte 2	Byte 3	Byte 4	Byte 5
0x4C	0x4C	0x20	0x20	0x20	0x20

◎ **MFR_MODEL_B0B5 (0x0086 – 0x0088)** is the first 6 codes of the manufacturer's model name (ASCII);

MFR_MODEL_B6B11 (0x0089 – 0x008B) is the last 6 codes of the manufacturer's model name (ASCII)

EX: Model name is DRS-480-24→MFRMODEL_B0B5 is DRS-48;

MFR_MODEL_B6B11 is 0-24

MFR_MODEL_B0B5					
Byte 0	Byte 1	Byte 2	Byte 3	Byte 4	Byte 5
0x44	0x52	0x53	0x2D	0x34	0x38

MFR_ID_B6B11					
Byte 6	Byte 7	Byte 8	Byte 9	Byte 10	Byte 11
0x30	0x2D	0x32	0x34	0x20	0x20

◎ **MFR_REVISION_B0B5(0x008C-0x008E)** is the firmware version. Arange of hexadecimal 0x00(R00.0)~0xFE(R25.4) represents the firmware version of an MCU; 0xFF represents no MCU existed.

EX1: The power supply has six MCUs. The firmware version of the MCU number 1 is version R01.3(0x0D), the MCU number 2 is version R01.2(0x0C), the MCU number 3 is version R01.1(0x0B), the other MCU numbers are version R01.0(0x0A).

Byte 0	Byte 1	Byte 2	Byte 3	Byte 4	Byte 5
0x0D	0x0C	0x0B	0x0A	0x0A	0x0A

EX2: The power supply has three MCUs. The firmware version of the MCU number 1 is version R25.4(0xFE), the MCU number 2 is version R10.5(0x69), the MCU number 3 is version R01.0(0x0A).

Byte 0	Byte 1	Byte 2	Byte 3	Byte 4	Byte 5
0xFE	0x69	0x0A	0xFF	0xFF	0xFF

◎ **MFR_DATE_B0B5(0x0091-0x0093)** is manufacture date (ASCII)

EX: MFR_DATE_B0B5 is 180101, meaning 2018/01/01

Byte 0	Byte 1	Byte 2	Byte 3	Byte 4	Byte 5
0x31	0x38	0x30	0x31	0x30	0x31

◎ **MFR_SERIAL_B0B5(0x0094-0x0096) · MFR_SERIAL_B6B11 (0x0097-0x0099)** are defined as manufacture date and manufacture serial number (ASCII)

EX: The first unit manufactured on 2018/01/01→MFR_SERIAL_B0B5: 180101; MER_SERIAL_B6B11: 000001

Byte 0	Byte 1	Byte 2	Byte 3	Byte 4	Byte 5
0x31	0x38	0x30	0x31	0x30	0x31

Byte 0	Byte 1	Byte 2	Byte 3	Byte 4	Byte 5
0x30	0x30	0x30	0x30	0x30	0x31

◎ **CURVE_CONFIG(0x00B4)(only for charger) :**

	Bit7	Bit6	Bit5	Bit4	Bit3	Bit2	Bit1	Bit0
Highbyte	Reserved	Reserved	Reserved	Reserved	Reserved	FVTOE	CVTOE	CCTOE
Lowbyte	CUVE	STGS	Reserved	Reserved	TCS		CUVS	

Low byte:

Bit 0:1 CUVS: Charge Curve Selection

00 = Customized charge curve (default)

01 = Gel battery

10 = Flooded battery

11 = AGM battery

Bit 2:3 TCS: Temperature Compensation Setting

00 = disable

01 = -3 mV/°C/cell (default)

10 = -4 mV/°C/cell

11 = -5 mV/°C/cell

Bit 4:5 Reserved: Currently not in use, retain (default is 0)

Bit 6 STGS: 2/3 Stage Charge setting (Not support)

0 = 3 stage charge (default, CURVE_CV and CURVE_FV)

1 = 2 stage charge (only CURVE_CV)

Bit 7 CUVE: Charge Curve Function Enable (defalut is 1, modification is not supported)

0 = OFF (VI mode)

1 = ON (Curve mode)

High byte:

Bit 0 CCTOE: Constant current stage timeout indication enable

0 = OFF (default)

1 = ON

Bit 1 CVTOE : Constant voltage stage timeout indication enable

0 = OFF (default)

1 = ON

Bit 2 FTTOE : Floating voltage stage timeout indication enable

0 = OFF (default)

1 = ON

Bit 3:7 Reserved: currently not in use, retain (default is 0)

Note: Not support settings display with "0"

© CHG_STATUS(0x00B8)(only for charger) :

	Bit7	Bit6	Bit5	Bit4	Bit3	Bit2	Bit1	Bit0
Highbyte	FVTOF	CVTOF	CCTOF	BUFFTOF	BTNC	NTCER	Reserved	Reserved
Lowbyte	DCM	Reserved	Reserved	Reserved	FVM	CVM	CCM	FULLM

Low byte:

- Bit 0 FULLM: Fully charged mode status
0 = NOT fully charged
1 = Fully charged
- Bit 1 CCM: Constant current mode status
0 = The charger NOT in constant current mode
1 = The charger in constant current mode
- Bit 2 CVM: Constant voltage mode status
0 = The charger NOT in constant voltage mode
1 = The charger in constant voltage mode
- Bit 3 FVM: Float mode status
0 = The charger NOT in float mode
1 = The charger in float mode
- Bit 4:6 Reserved: Currently not in use, retain (default is 0)
- Bit 7 DCM: Battery discharge mode
0 = Charging
1 = Discharging

High byte:

- Bit 0:1 Reserved: Currently not in use, retain (default is 0)
- Bit 2 NTCER: Temperature compensation status
0 = NO short-circuit in the circuitry of temperature compensation
1 = the circuitry of temperature compensation has short-circuited
- Bit 3 BTNC: Battery detection
0 = Battery detected
1 = NO battery detected
- Bit 4 BUFFTOF: Time out flag of buffering
0 = NO time out in buffering
1 = Buffering time out

- Bit 5 CCTOF: Time out flag of constant current mode
0 = NO time out in constant current mode
1 = Constant current mode time out
- Bit 6 CVTOF : Time out flag of constant voltage mode
0 = NO time out in constant voltage mode
1 = Constant voltage mode time out
- Bit 7 FVTOF: Time out flag of float mode
0 = NO time out in float mode
1 = Float mode time out

Note: Not support settings display with "0"

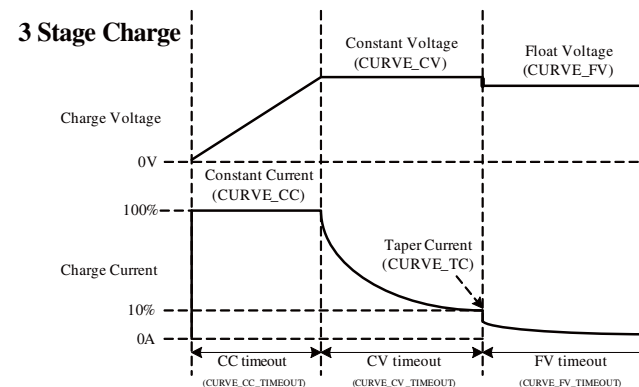
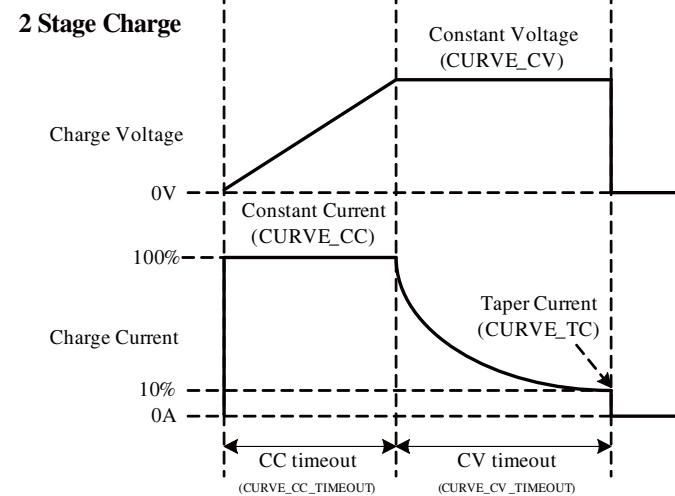

© SCALING_FACTOR(0x00C0-0x00C2) :

	Bit7	Bit6	Bit5	Bit4	Bit3	Bit2	Bit1	Bit0
Byte5	Reserved				Reserved			
	Bit7	Bit6	Bit5	Bit4	Bit3	Bit2	Bit1	Bit0
Byte4	Reserved				Reserved			
	Bit7	Bit6	Bit5	Bit4	Bit3	Bit2	Bit1	Bit0
Byte3	Reserved				IIN Factor			
	Bit7	Bit6	Bit5	Bit4	Bit3	Bit2	Bit1	Bit0
Byte2	CURVE_TIMEOUT Factor				TEMPERATURE_1 Factor			
	Bit7	Bit6	Bit5	Bit4	Bit3	Bit2	Bit1	Bit0
Byte1	FAN_SPEED Factor				VIN Factor			
	Bit7	Bit6	Bit5	Bit4	Bit3	Bit2	Bit1	Bit0
Byte0	IOUT Factor				VOUT Factor			

Byte0:

Bit 0:3 VOUT Factor : The factor of output voltage

- 0x0=Not support output voltage relevant commands
- 0x1~0x3=Currently not in use, retain (default is 0)
- 0x4=0.001
- 0x5=0.01
- 0x6=0.1
- 0x7=1.0
- 0x8=10
- 0x9=100
- 0xA~0xF= Reserved

Bit 4:7 IOUT Factor : The factor of DC current

- 0x0=Not support output current relevant commands
- 0x1~0x3=Currently not in use, retain (default is 0)
- 0x4=0.001
- 0x5=0.01
- 0x6=0.1
- 0x7=1.0
- 0x8=10
- 0x9=100
- 0xA~0xF= Reserved

Byte1:

Bit 0:3 VIN Factor : The factor of AC input voltage

- 0x0=Not support AC input relevant commands
- 0x1~0x3=Currently not in use, retain (default is 0)
- 0x4=0.001
- 0x5=0.01
- 0x6=0.1
- 0x7=1.0
- 0x8=10
- 0x9=100
- 0xA~0xF= Reserved

Bit 4:7 FAN_SPEED Factor : The factor of fan speed

- 0x0=Not support fan speed relevant commands
- 0x1~0x3=Currently not in use, retain (default is 0)
- 0x4=0.001
- 0x5=0.01
- 0x6=0.1
- 0x7=1.0
- 0x8=10
- 0x9=100
- 0xA~0xF= Reserved

Byte2:

Bit 0:3 TEMPERATURE_1 Factor : The factor of internal ambient temperature

- 0x0=Not support internal ambient temperature relevant commands
- 0x1~0x3=Currently not in use, retain (default is 0)
- 0x4=0.001
- 0x5=0.01
- 0x6=0.1
- 0x7=1.0
- 0x8=10
- 0x9=100
- 0xA~0xF= Reserved

Bit 4:7 CURVE_TIMEOUT Factor : The factor of CC/CV/Float timeout

- 0x0=Not support CURVE_TIMEOUT relevant commands
- 0x1~0x3=Currently not in use, retain (default is 0)
- 0x4=0.001
- 0x5=0.01
- 0x6=0.1
- 0x7=1.0
- 0x8=10
- 0x9=100
- 0xA~0xF= Reserved

Byte3:

Bit 0:3 IIN Factor : The factor of AC input current

- 0x0=Not support AC input current relevant commands
- 0x1~0x3=Currently not in use, retain (default is 0)
- 0x4=0.001
- 0x5=0.01
- 0x6=0.1
- 0x7=1.0
- 0x8=10
- 0x9=100
- 0xA~0xF= Reserved

Bit 4:7 Reserved : Currently not in use, retain (default is 0)

Byte4~Byte5:

Bit 0:7 Reserved : Currently not in use, retain (default is 0)

◎ SYSTEM_STATUS(0x00C3) :

	Bit7	Bit6	Bit5	Bit4	Bit3	Bit2	Bit1	Bit0
High byte	Reserved	Reserved	Reserved	Reserved	Reserved	Reserved	Reserved	Reserved
Low byte	CHG/UPS	EEPER	INITIAL_STATE	ADL_ON	ORING_OFF	PFC_OK	DC_OK	M/S

Low byte:

- Bit 0 M/S : Parallel mode (Not support)
 - 0 = Slave
 - 1 = Master
- Bit 1 DC_OK : Secondary DC output voltage status
 - 0 = Secondary DD output voltage status TOO LOW
 - 1 = Secondary DD output voltage status NORMAL
- Bit 2 PFC_OK : Primary side PFC output voltage status (Not support)
 - 0 = Primary side PFC no starting or abnormal
 - 1 = Primary side PFC normal
- Bit 3 ORING_OFF : ORING MOS OFF (Not support)
 - 0 = DD start-up, ORING MOS controller ON
 - 1 = DD start-up, force control ORING MOS OFF
- Bit 4 ADL_ON : Active dummy load control state (Not support)
 - 0 = Active dummy load OFF/Not support
 - 1 = Active dummy load ON
- Bit 5 INITIAL_STATE : Device initialized status
 - 0 = In initialization status
 - 1 = NOT in initialization status
- Bit 6 EEPER : EEPROM data access error
 - 0 = Normal EEPROM data access
 - 1 = Abnormal EEPROM data access
- Bit 7 CHG/UPS : Operation status
 - 0 = Charging mode
 - 1 = UPS mode

High byte:

Bit 0:7 Reserved : Currently not in use, retain (default is 0)

Note: Not support settings display with "0"

◎ SYSTEM_CONFIG(0x00C4) :

	Bit7	Bit6	Bit5	Bit4	Bit3	Bit2	Bit1	Bit0
High byte	-	-	-	-	-	EEP_OFF	EEP_CONFIG	
Low byte	-	-	-	-	-	OPERATION_INIT		MOD_CTRL

Low byte:

- Bit 0 MOD_CTRL : Modbus control status (Not support)
 - 0 = SVR
 - 1 = Modbus (VOUT_SET, IOOUT_SET, OPERATION)
- Bit 1:2 OPERATION_INIT : Pre-set value of power on operation command
 - 0b00 = Power OFF, pre-set 0x00(OFF)
 - 0b01 = Power ON, pre-set 0x01(ON)
 - 0b10 = Pre-set is previous set value
 - 0b11 = Reserved, currently not in use
- Bit 3:7 Reserved : Currently not in use, retain (default is 0)

High Byte:

- Bit 0:1 EEP_CONFIG: EEPROM Configuration
 - 00: Immediate. Changes to parameters are written to EEPROM immediately (factory default)
 - 01: 1 minute delay. Write changes to EEPROM if all parameters remain unchanged for 1 minute
 - 10: 10 minute delay. Write changes to EEPROM if all parameters remain unchanged for 10 minutes
 - 11: Reserved
- Bit 2 EEP_OFF: EEPROM storage function ON/OFF
 - 0: Enable. Parameters to be saved into EEPROM (factory default)
 - 1: Disable. Parameters NOT to be saved into EEPROM

Note: Not support settings display with "0"

© UPS_CONFIG(0x00D2) :

	Bit7	Bit6	Bit5	Bit4	Bit3	Bit2	Bit1	Bit0
High byte	Reserved	Reserved	Reserved	Reserved	Reserved	Reserved	Reserved	Reserved
Low byte	Reserved	Reserved	UPS_Shutdown_EN	UPS_Delay_EN	Wake_Up_EN	Time_Buff_EN	UPS_OFF_EN	Life_Test_EN

Low byte:

- Bit 0 Life_Test_EN : Battery self-test function
 - 0 = OFF
 - 1 = ON(default)
- Bit 1 UPS_OFF_EN : Force start state via button to shut down
 - 0 = OFF(default)
 - 1 = ON
- Bit 2 Time_Buff_EN : Time Buffering setting function
 - 0 = OFF(default)
 - 1 = ON
- Bit 3 Wake_Up_EN: Wake up the batteries (to activate the lithium batteries)
 - 0 = OFF
 - 1 = On (default)
- Bit 4 UPS_Delay_EN: Delay to shut down when in UPS mode
 - 0 = OFF (default)
 - 1 = ON
- Bit 5 UPS_Shutdown_EN: Enable to set the restart time when in UPS mode.
 - 0 = OFF(default)
 - 1 = ON
- Bit 6:7 Reserved : Currently not in use, retain (default is 0)

Note:1. The description of time Buffering/UPS_Delay_Time /UPS_Shutdown_Time

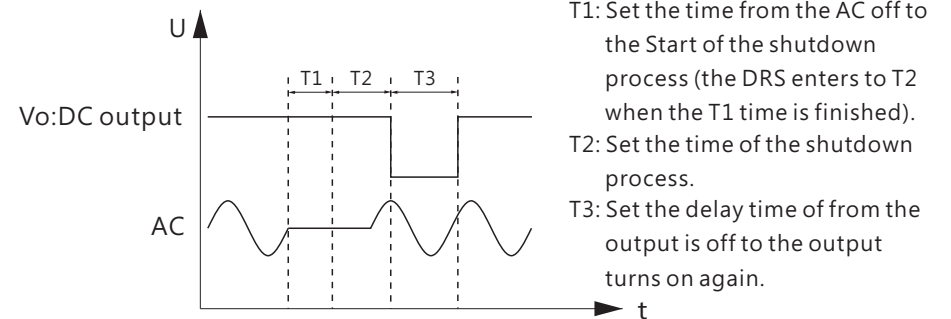

T1 can be set by the command address 0XE4 (Time Buffering), please refer to chapter 5.4.1.6 for details;

T2 can be set by the command address 0XE8 (UPS_Delay_Time), please refer to chapter 5.4.1.6 for details;

T3 can be set by the command address 0XE9 (UPS_Shutdown_Time), please refer to chapter 5.4.1.6 for details.

Note: 2. The description of Wake_up

When the DRS turns on, it establishes a stable output voltage, which is the rated output voltage.

After 5 secs, the output voltage will drop to 70% rated voltage, then gradually raises to the voltage of the batteries. If no batteries connect, the voltage will raise to 130% rated voltage, then drops to the rated voltage.

After this time, the wake_up process ends and the charging begins.

After turning on, the wake_up process is performed every 5 mins.

This command can turn off wake_up process (Wake_Up_EN=0) that occurs every 5 mins, but the one at turnig on the DRS cannot be turned off.

Note: 3. The description of Life_Test

When $V_{bat} \geq$ the rated output and the charging current $\geq 5\%$, the DRS will have a battery test every 30s to detect whether the battery is normal or not (default is on). If the DRS detects that the battery is less than the voltage of the limit of to BAT_Low, it's considered an abnormal state, the VBAT will adjust to the rated output voltage.

- Diagram of the output voltage over time when the batteries are not connected.

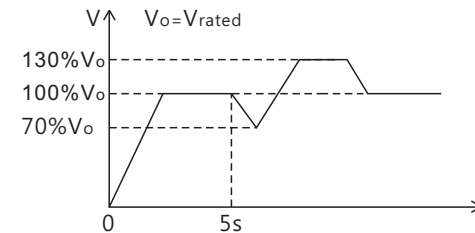

- Diagram of the output voltage over time when the batteries are connected.

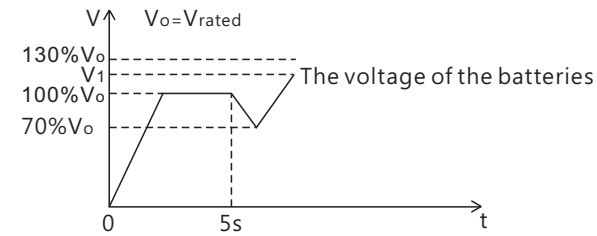

High byte :

Bit 0:7 Reserved : Currently not in use, retain (default is 0)

Note: Not support settings display with "0"

5.4.2 Communication examples

The following provides examples of request and response for each function code of the Modbus RTU.

5.4.2.1 Read holding register (FC=03)

The request message specifies the starting register and quantity of registers to be read.

For example: the master requests the content of analog output holding registers 0x0080~0x0085 (MFR_ID_B0B5, MFR_ID_B6B11) from slave 3.

Request:

0x83	0x03	0x00 80	0x00 06	0xDA 02
------	------	---------	---------	---------

0x83 : Slave ID 3

0x03 : Function code 3 (Read analog output holding R registers)

0x00 80 : The data address of the first register requested

0x00 06 : The total number of registers requested (Read 6 registers 0x0080~ 0x0085)

0xDA 02 : CRC-16 error check. Please be aware that CRC sending the low byte first.

Response :

0x83	0x03	0x0C	0x4D 45 41 4E 57 45 4C 4C 20 20 20 20	0x4A 8C
------	------	------	--	---------

0x83 : Slave ID 3

0x03 : Function code 3 (Read analog output holding R registers)

0x0C : The number of data bytes to follow (12 bytes)

0x4D 45 41 4E 57 45 4C 4C 20 20 20 20 : means that the manufacture name of the slave is MEAN WELL

0x4A 8C: CRC-16 error check. Please be aware that CRC sending the Low byte first.

5.4.2.2 Read Input register (FC=04)

The request message specifies the starting register and quantity of registers to be read.

For example: The master requests the content of analog input register 0x0060 (READ_VOUT) from slave 3.

Request:

0x83	0x04	0x00 60	0x00 01	0x2F F6
------	------	---------	---------	---------

0x83 : Slave ID 3

0x04 : Function code 4 (Read analog input registers)

0x00 60 : The data address of the first register requested

0x00 01 : The total number of registers requested (Read only 1 register from 0x0060)

0x2F F6 : CRC-16 error check. Please be aware that CRC sending the Low byte first.

Response :

0x83	0x04	0x02	0x15 7C	0xCE 5F
------	------	------	---------	---------

0x83 : Slave ID 3

0x04 : Function code 4 (Read analog input register)

0x02 : The number of data bytes to follow (2 bytes)

0x15 7C : The contents of register: HEX 0x15 7C = DEC 5500 = 55.00V

0xCE 5F: CRC-16 error check. Please be aware that CRC sending the Low byte first.

5.4.2.3 Write Single register (FC=06)

The request message specifies the register reference to be written. For example: the master writes PSU ON to analog output holding register of 0x0000 (OPERATION) for slave 3.

Request:

0x83	0x06	0x00 00	0x00 01	0x56 28
------	------	---------	---------	---------

0x83 : Slave ID 3

0x06 : Function code 6 (Pre-set single register)

0x00 00 : The data address of the register

0x00 01 : The value to write

0x56 28 : CRC-16 error check. Please be aware that CRC sending the Low byte first.

Response :

The normal response is an echo of the query, returned after the register contents have been written.

5.4.3 Modbus practical operation

The following steps will describe how to set the DRS-240-48 to 56V (for DRS-240-48, the output voltage range is 40V~56V)

1. Confirm the address of the DRS-240-48

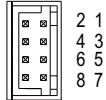

(Refer to chapter 5.4.1.4: Additional Address Definition)

CN12

Between A0/A1 and GND(Single)	Logic
Open	1
Short	0

Device No.	Devices	Address
	A1	A0
0	0	0
1	0	1
2	1	0
3	1	1

Slave ID	Description
0x8X	X means device address

So the address of the DRS-240-48 is 0x83.

2. Connect the DATA+ / DATA- Pins of the master to the corresponding DATA+(PIN6) and DATA-(PIN7) Pins of the RJ45 Connector on the supply. It is recommended to establish a common ground for the communication system to increase its communication reliability by using GND_Aux(PIN8) of RJ45

Physical layer setting as below:

Control	Setting
Baud Rate	115200
Data Bits	8
Stop Bit	1
Parity	None
Flow Control	None

© Adding a 120u termination resistor to both the controller and the supply's end can increase the communication stability.

© If the unit is a terminal, its recommended to connect a termination resistor

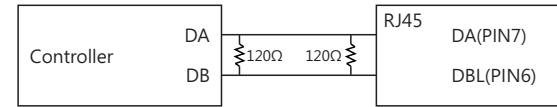

3. Set the output voltage to 56V

Slave Address	Function Code	The number of data bytes to follow	Data	CRC
0x83	0x03	0x01	0x15E0	0x5074

0x83: Slave ID83

0x06: Function Code 6(Write Single Register)

0x0020: VOUT_SET register

0x15E0: 56V 1560010x15E0

0x4875: CRC16 Error checking

Note: Conversion factor for VOUT_SET is $0.01 \cdot \text{so} \frac{56V}{0.01} = 5600$

4. It is recommended to review all the settings and parameters using the appropriate. In the event that they do not meet your requirements, you may rewrite them as needed.

EX: Read VOUT_SET to check whether the output voltage was set to a proper VOUT_Set to check whether the output voltage was set to a proper level.

Read VOUT_SET:

Slave Address	Function Code	Data Address of the first register requested	The total number of requested	CRC
0x83	0x03	0x0020	0x0001	0x9BE2

Slave Address	Function Code	The number of data bytes to follow	Data	CRC
0x83	0x03	0x01	0x15E0	0x0574

Data:0x15E0 → 5600=56V

5. Finally, if there's no output voltage, to check whether the AC is connected; if hot, you can short the PIN7. PIN8 of CN12 or long press the Battery start button for 3 sec then released, refer to chapter 5.7 for details.

5.4.4 CANBus communication

- Physical layer
This protocol complies with CAN ISO-11898, and baud rate is 250Kbps.
- Protocol frame format
The protocol complies with CAN 2.0B, the extended frame format.

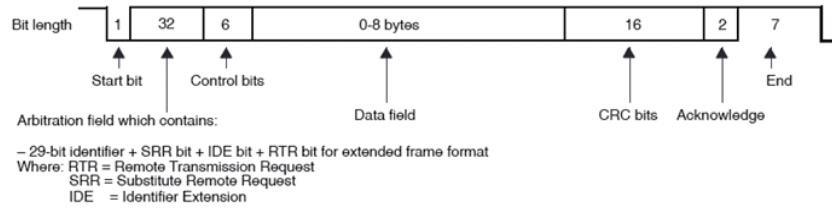

- Communication interface
 Min. request period (Controller to PSU/CHG): 20mSec ◦
 Max. response time (PSU/CHG to Controller): 5mSec ◦
 Min. packet margin time (Controller to PSU/CHG): 5mSec ◦

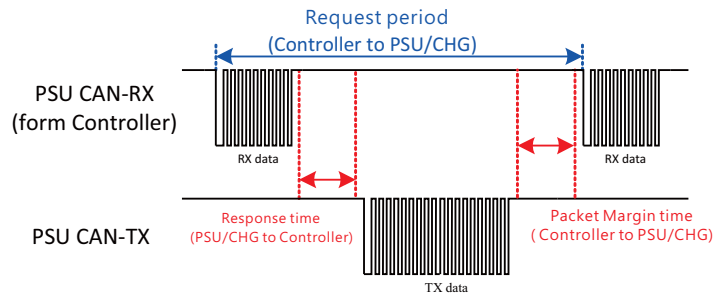

5.4.4.1 Message ID

Description	Message ID
Message ID of DRS	0x000C00XX
Message ID of Master	0x000C01XX
Broadcast	0x000C01FF

PS : XX means device address of DRS (depend on A0~A1, from 0x00 to 0x03)

5.4.4.2 CANBus command list

Command Code	Command Name	Transaction Type	# of data Bytes	Description
0x0000	OPERATION	R/W	1	Remote ON/OFF
0x0020	VOUT_SET	R/W	2	Output voltage set (format: value, F=0.01)
0x0040	FAULT_STATUS	R	2	Abnormal status
0x0050	READ_VIN	R	2	Input voltage read value (format: value, F=0.1)
0x0060	READ_VOUT	R	2	Output voltage (format: value, F=0.01)
0x0061	READ_IOUT	R	2	Output current (format: value, F=0.01)
0x0062	READ_TEMPERATURE_1	R	2	Internal ambient temperature (format: value, F=0.1)
0x0080	MFR_ID_B0B5	R	6	Manufacture's name
0x0081	MFR_ID_B6B11	R	6	Manufacture's name
0x0082	MFR_MODEL_B0B5	R	6	Manufacture model
0x0083	MFR_MODEL_B6B11	R	6	Manufacture model
0x0084	MFR_REVISION_B0B5	R	6	Firmware version
0x0085	MFR_LOCATION_B0B2	R/W	3	Manufacture place
0x0086	MFR_DATE_B0B5	R/W	6	Manufacture date

0x0087	MFR_SERIAL_B0B5	R/W	6	Manufacture serial number
0x0088	MFR_SERIAL_B6B11	R/W	6	Manufacture serial number
0x00B0	CURVE_CC	R/W	2	Constant current setting (format: value, F=0.01)
0x00B1	CURVE_CV	R/W	2	Constant voltage setting (format: value, F=0.01)
0x00B2	CURVE_FV	R/W	2	Floating voltage setting (format: value, F=0.01)
0x00B3	CURVE_TC	R/W	2	Taper current setting (format: value, F=0.01)
0x00B4	CURVE_CONFIG	R/W	2	Configuration setting
0x00B5	CURVE_CC_TIMEOUT	R/W	2	CC charge timeout setting
0x00B6	CURVE_CV_TIMEOUT	R/W	2	CV charge timeout setting
0x00B7	CURVE_FV_TIMEOUT	R/W	2	FV charge timeout setting
0x00B8	CHG_STATUS	R	2	Charging status reporting (only for charger)
0x00C0	SCALING_FACTOR	R	2	Scaling ratio
0x00C1	SYSTEM_STATUS	R	2	System status
0x00C2	SYSTEM_CONFIG	R/W	2	System configuration
0x00D0	BAT_UVP_SET	R/W	2	BAT_LOW protect setting
0x00D1	Force_BAT_UVP_SET	R/W	2	Force BAT_LOW protect setting
0x00D2	UPS_CONFIG	R/W	2	UPS config setting
0x00D3	READ_VBAT	R	2	Voltage of battery (format: value, F=0.01)

0x00D4	READ_IBAT	R	2	Charging or discharging current of battery (format: value, F=0.01)
0x00D5	READ_BAT_TEMPERATURE	R	2	Temperature of battery (format: value, F=0.1)
0x00D6	CHARGE_CYCLES	R/W	2	Charge cycles (Not support)
0x00D7	AH_CHARGED	R/W	2	Battery capacity (Not support)
0x00E0	AC_Fail_LL_SET	R/W	2	AC fail low line point setting
0x00E1	AC_Fail_HL_SET	R/W	2	AC fail high line point setting
0x00E2	AC_OK_LL_SET	R/W	2	AC OK low line point setting
0x00E3	AC_OK_HL_SET	R/W	2	AC OK high line point setting
0x00E4	TIME_BUFFERING	R/W	2	Buffering time setting
0x00E5	BACKUP	R/W	2	Backup power counting (Not support)
0x00E6	RUN_TIME	R/W	4	Running time (Not support)
0x00E7	UPS_Delay_Time	R/W	2	UPS shutdown delay time setting
0x00E8	UPS_Shutdown_Time	R/W	2	UPS shutdown time setting

Note: 1. The conversion of setting and reading values is defined as following:

Actual value= Communication reading value × F actor (F value).

Among them Factor needs to refer to the definition of SCALING_FACTOR in each model list.

EX: $V_{o_real}(\text{actual DC voltage}) = \text{READ_VOUT} \times F \text{ actor}$.

If the Factor of READ_VOUT of a certain model is 0.01, the communication reading value is 0x0960(hexadecimal)→2400(decimal), then $V_{o_real} = 2400 \times 0.01 = 24.00V$.

1. The Time_Buffering setting takes effect only when the bit2 of the low bytes of UPS_CONFIG(0x00D2)=1
2. The UPS_Delay_Time setting takes effect only when the bit 4 of the low byte of UPS_CONFIG (0x00D2) is 1.
3. The UPS_Shutdown_Time setting takes effect only when the bit 5 of the low byte of UPS_CONFIG (0x00D2) is 1.

◎ FAULT_STATUS(0x0040) :

Bit7	Bit6	Bit5	Bit4	Bit3	Bit2	Bit1	Bit0
High byte	Reserved	Reserved	Reserved	Reserved	Reserved	Reserved	Reserved
Low byte	OP_OFF	AC_FAIL	SHORT	OLP	OVP	OTP	FAN_FAIL

Low byte:

Bit 0 FAN_FAIL : Fan abnormal state (Not support)

- 0 = Normal state
- 1 = Abnormal state

Bit 1 OTP : Over temperature protection

- 0 = Normal internal temperature
- 1 = Abnormal internal temperature

Bit 2 OVP : Output over-voltage protection

- 0 = Normal output voltage
- 1 = Abnormal output

Bit 3 OLP : Output over current protection

- 0 = Normal output current
- 1 = Abnormal output current

Bit 4 SHORT : Short circuit protection

- 0 = Shorted circuit does not exist
- 1 = Shorted circuit protected

Bit 5 AC_FAIL : AC abnormal flag

- 0 = Normal AC range
- 1 = Abnormal AC range

Bit 6 OP_OFF : DC status

- 0 = DC turned on
- 1 = DC turned off

Bit 7 HI_TEMP : High ambient temperature protection

- 0 = Normal ambient temperature
- 1 = Abnormal ambient temperature

High byte:

Bit 0:7 Reserved : Currently not in use, retain (default is 0)

Note: Unsupported settings displays with "0"

◎ MFR_ID_B0B5(0x0080) is the first 6 codes of the manufacturer's name (ASCII);

MFR_ID_B6B11(0x0081) is the last 6 codes of the manufacturer's name (ASCII)

EX: manufacturer's name is MEANWELL→MFR_ID_B0B5 is MEANWE;
MFR_ID_B6B11 is LL

MFR_ID_B0B5					
Byte 0	Byte 1	Byte 2	Byte 3	Byte 4	Byte 5
0x4D	0x45	0x41	0x4E	0x57	0x45

MFR_ID_B6B11					
Byte 0	Byte 1	Byte 2	Byte 3	Byte 4	Byte 5
0x4C	0x4C	0x20	0x20	0x20	0x20

◎ MFR_MODEL_B0B5(0x0082) is the first 6 codes of the manufacturer's model name (ASCII);

MFR_MODEL_B6B11(0x0083) is the last 6 codes of the manufacturer's model name (ASCII)

EX: Model name is DRS-480-24→MFRMODEL_B0B5 is DRS-48;
MFR_MODEL_B6B11 is 0-24

MFR_MODEL_B0B5					
Byte 0	Byte 1	Byte 2	Byte 3	Byte 4	Byte 5
0x44	0x52	0x53	0x2D	0x34	0x38

MFR_ID_B6B11					
Byte 6	Byte 7	Byte 8	Byte 9	Byte 10	Byte 11
0x30	0x2D	0x32	0x34	0x20	0x20

◎ MFR_REVISION_B0B5(0x0084) is the firmware version. Arrange of hexadecimal 0x00(R00.0)~0xFE(R25.4) represents the firmware version of an MCU; 0xFF represents no MCU existed.

EX1: The power supply has six MCUs. The firmware version of the MCU number 1 is version R01.3(0x0D), the MCU number 2 is version R01.2(0x0C), the MCU number 3 is version R01.1(0x0B), the other MCU numbers are version R01.0(0x0A)

Byte 0	Byte 1	Byte 2	Byte 3	Byte 4	Byte 5
0x0D	0x0C	0x0B	0x0A	0x0A	0x0A

EX2: The power supply has three MCUs. The firmware version of the MCU number 1 is version R25.4(0xFE), the MCU number 2 is version R10.5(0x69), the MCU number 3 is version R01.0(0x0A).

Byte 0	Byte 1	Byte 2	Byte 3	Byte 4	Byte 5
0xFE	0x69	0x0A	0xFF	0xFF	0xFF

© MFR_DATE_B0B5(0x0086) is manufacture date (ASCII)

EX: MFR_DATE_B0B5 is 180101, meaning 2018/01/01

Byte 0	Byte 1	Byte 2	Byte 3	Byte 4	Byte 5
0x31	0x38	0x30	0x31	0x30	0x31

© MFR_SERIAL_B0B5(0x0087) · MFR_SERIAL_B6B11(0x0088) are defined as manufacture date and manufacture serial number (ASCII)

EX: The first unit manufactured on 2018/01/01→MFR_SERIAL_B0B5: 180101; MER_SERIAL_B6B11: 000001

Byte 0	Byte 1	Byte 2	Byte 3	Byte 4	Byte 5
0x31	0x38	0x30	0x31	0x30	0x31

Byte 0	Byte 1	Byte 2	Byte 3	Byte 4	Byte 5
0x30	0x30	0x30	0x30	0x30	0x31

© CURVE_CONFIG(0x00B4)(only for charger) :

								Bit0
Highbyte	Reserved	Reserved	Reserved	Reserved	Reserved	FVTOE	CVTOE	CCTOE
Lowbyte	CUVE	STGS	Reserved	Reserved	TCS		CUVS	

Low byte:

Bit 0:1 CUVS : Charge Curve Selection

- 00 = Customized charge curve (default)
- 01 = Gel battery
- 10 = Flooded battery
- 11 = AGM battery

Bit 2:3 TCS : Temperature Compensation Setting

- 00 = disable
- 01 = -3 mV/°C/cell (default)
- 10 = -4 mV/°C/cell
- 11 = -5 mV/°C/cell

Bit 4:5 Reserved : Currently not in use, retain (default is 0)

Bit 6 STGS : 2/3 Stage Charge setting (Not support)

- 0 = 3 stage charge (default, CURVE_CV and CURVE_FV)
- 1 = 2 stage charge (only CURVE_CV)

Bit 7 CUVE : Charge Curve Function Enable (default is 1, modification is not supported)

- 0 = OFF(VI mode)
- 1 = ON(Curve mode)

High byte:

Bit 0 CCTOE : Constant current stage timeout indication enable

- 0 = OFF (default)
- 1 = ON

Bit 1 CVTOE : Constant voltage stage timeout indication enable

- 0 = OFF (default)
- 1 = ON

Bit 2 FTTOE : Floating voltage stage timeout indication enable

- 0 = OFF (default)
- 1 = ON

Bit 3:7 Reserved : Currently not in use, retain (default is 0)

Note: Not support settings display with "0"

© CHG_STATUS(0x00B8)(only for charger) :

	Bit7	Bit6	Bit5	Bit4	Bit3	Bit2	Bit1	Bit0
Highbyte	FVTOF	CVTOF	CCTOF	BUFFTOF	BTNC	NTCER	Reserved	Reserved
Low byte	DCM	Reserved	Reserved	Reserved	FVM	CVM	CCM	FULLM

Low byte:

- Bit 0 FULLM : Fully charged mode status
0 = NOT fully charged
1 = Fully charged
- Bit 1 CCM : Constant current mode status
0 = The charger NOT in constant current mode
1 = The charger in constant current mode
- Bit 2 CVM : Constant voltage mode status
0 = The charger NOT in constant voltage mode
1 = The charger in constant voltage mode
- Bit 3 FVM : Float mode status
0 = The charger NOT in float mode
1 = The charger in float mode
- Bit 4:6 Reserved : Currently not in use, retain (default is 0)
- Bit 7 DCM : Battery discharge mode
0 = Charging
1 = Discharging

High byte:

- Bit 0:1 Reserved : Currently not in use, retain (default is 0)
- Bit 2 NTCER : Temperature compensation status
0 = NO short-circuit in the circuitry of temperature compensation
1 = the circuitry of temperature compensation has short-circuited
- Bit 3 BTNC : Battery detection
0 = Battery detected
1 = NO battery detected
- Bit 4 BUFFTOF : Time out flag of buffering
0 = NO time out in buffering
1 = Buffering time out
- Bit 5 CCTOF : Time out flag of constant current mode
0 = NO time out in constant current mode
1 = Constant current mode time out
- Bit 6 CVTOF : Time out flag of constant voltage mode
0 = NO time out in constant voltage mode
1 = Constant voltage mode time out

Bit 7 FVTOF : Time out flag of float mode

- 0 = NO time out in float mode
- 1 = Float mode time out

Note: Not support settings display with "0"

Diagram of charging curve:

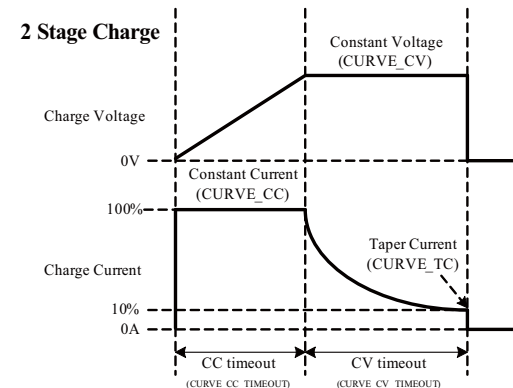
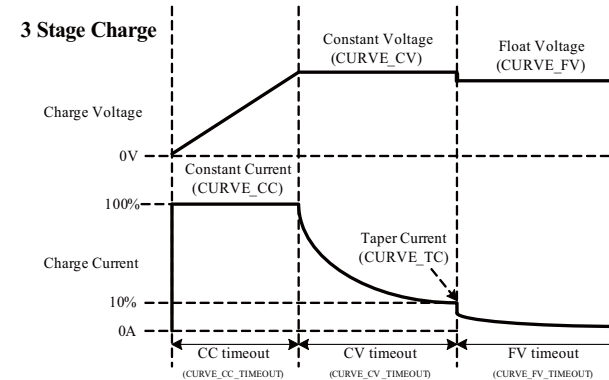

© SYSTEM_STATUS(0x00C1):

	Bit7	Bit6	Bit5	Bit4	Bit3	Bit2	Bit1	Bit0
High byte	Reserved	Reserved	Reserved	Reserved	Reserved	Reserved	Reserved	Reserved
Low byte	CHG/UPS	EEPER	INITIAL_STATE	ADL_ON	ORING_OFF	PFC_OK	DC_OK	M/S

Low byte:

- Bit 0 M/S : Parallel mode (Not support)
0 = Slave
1 = Master
- Bit 1 DC_OK : Secondary DC output voltage status
0 = Secondary DD output voltage status TOO LOW
1 = Secondary DD output voltage status NORMAL
- Bit 2 PFC_OK : Primary side PFC output voltage status (Not support)
0 = Primary side PFC no starting or abnormal
1 = Primary side PFC normal
- Bit 3 ORING_OFF : ORING MOS OFF (Not support)
0 = DD start-up, ORING MOS controller ON
1 = DD start-up, force control ORING MOS OFF
- Bit 4 ADL_ON : Active dummy load control state (Not support)
0 = Active dummy load OFF/Not support
1 = Active dummy load ON
- Bit 5 INITIAL_STATE : Device initialized status
0 = In initialization status
1 = NOT in initialization status
- Bit 6 EEPER : EEPROM data access error
0 = Normal EEPROM data access
1 = Abnormal EEPROM data access
- Bit 7 CHG/UPS : Operation status
0 = Charging mode
1 = UPS mode

High byte:

Bit 0:7 Reserved : Currently not in use, retain (default is 0)

Note: Not support settings display with "0"

© SYSTEM_CONFIG(0x00C2) :

	Bit7	Bit6	Bit5	Bit4	Bit3	Bit2	Bit1	Bit0
High byte	-	-	-	-	-	EEP_OFF	EEP_CONFIG	
Low byte	-	-	-	-	-	OPERATION_INIT		CAN_CTRL

Low byte:

- Bit 0 CAN_CTRL : CANBus control status (Not support)
0 = SVR
1 = CANBus(VOUT_SET, IOUT_SET, OPERATION)
- Bit 1:2 OPERATION_INIT : Pre-set value of power on operation command
0b00 = Power OFF, pre-set 0x00(OFF)
0b01 = Power ON, pre-set 0x01(ON)
0b10 = Pre-set is previous set value
0b11 = Reserved, currently not in use
- Bit 3:7 Reserved : Currently not in use, retain (default is 0)

High Byte:

- Bit 0:1 EEP_CONFIG: EEPROM Configuration
00: Immediate. Changes to parameters are written to EEPROM immediately (factory default)
01: 1 minute delay. Write changes to EEPROM if all parameters remain unchanged for 1 minute
10: 10 minute delay. Write changes to EEPROM if all parameters remain unchanged for 10 minutes
11: Reserved
- Bit 2 EEP_OFF: EEPROM storage function ON/OFF
0: Enable. Parameters to be saved into EEPROM (factory default)
1: Disable. Parameters NOT to be saved into EEPROM

Note: Not support settings display with "0"

© UPS_CONFIG(0x00D2) :

	Bit7	Bit6	Bit5	Bit4	Bit3	Bit2	Bit1	Bit0
High byte	Reserved	Reserved	Reserved	Reserved	Reserved	Reserved	Reserved	Reserved
Low byte	Reserved	Reserved	UPS_Shutdown_EN	UPS_Delay_EN	Wake_Up_EN	Time_Buff_EN	UPS_OFF_EN	Life_Test_EN

Low byte:

Bit 0 Life_Test_EN : Battery self-test function

0 = OFF

1 = ON(default)

Bit 1 UPS_OFF_EN : Force start state via button to shut down

0 = OFF(default)

1 = ON

Bit 2 Time_Buff_EN : Time_Buffering setting function

0 = OFF(default)

1 = ON

Bit 3 Wake_Up_EN: Wake up the batteries (to activate the lithium batteries)

0 = OFF

1 = On (default)

Bit 4 UPS_Delay_EN: Delay to shut down when in UPS mode

0 = OFF (default)

1 = ON

Bit 5 UPS_Shutdown_EN: Enable to set the restart time when in UPS mode.

0=OFF(default)

1=ON

Bit 6:7 Reserved : Currently not in use, retain (default is 0)

T1 can be set by the command address 0XE4 (Time Buffering), please refer to chapter 5.4.4 for details;

T2 can be set by the command address 0XE7 (UPS_Delay_Time), please refer to chapter 5.4.4 for details;

T3 can be set by the command address 0XE8 (UPS_Shutdown_Time), please refer to chapter 5.4.4 for details.

Note: 2. The description of Wake_up

When the DRS turns on, it establishes a stable output voltage, which is the rated output voltage.

After 5 secs, the output voltage will drop to 70% rated voltage, then gradually raises to the voltage of the batteries. If no batteries connect, the voltage will raise to 130% rated voltage, then drops to the rated voltage.

After this time, the wake_up process ends and the charging begins.

After turning on, the wake_up process is performed every 5 mins.

This command can turn off wake_up process(Wake_Up_EN=0) that occurs every 5 mins, but the one at turnig on the DRS cannot be turned off.

Note: 3. The description of Life_Test

When $V_{bat} \geq$ the rated output and the charging current $\geq 5\%$, the DRS will have a battery test every 30s to detect whether the battery is normal or not (default is on). If the DRS detects that the battery is less than the voltage of the limit of to BAT_Low, it's considered an abnormal state, the VBAT will adjust to the rated output voltage.

Note:1. The description of time Buffering/UPS_Delay_Time /UPS_Shutdown_Time

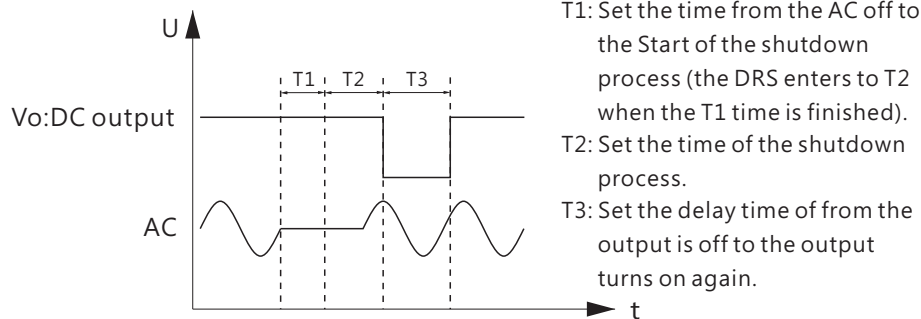

- Diagram of the output voltage over time when the batteries are not connected.

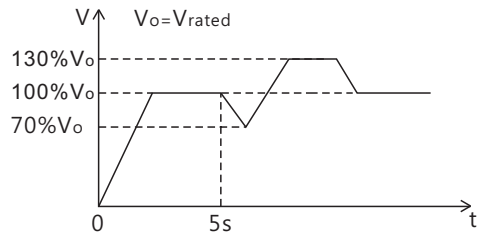

- Diagram of the output voltage over time when the batteries are connected.

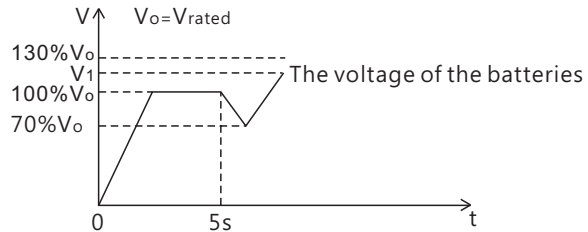

High byte :

Bit 0:7 Reserved : Currently not in use, retain (default is 0)

Note: Not support settings display with "0"

5.4.5 CANBus communication examples

5.4.5.1 Sending command

The master adjusts the output voltage of the unit with the address " 03" to 30V.

CAN ID	DLC(data length)	Command Code	Parameters
0xC0103	0x04	0x2000	0xB80B

Command Code: 0X0020(Vout_Set) → 0x0020(Low)+0x00(High)

Parameters: 30V → 3000V → 0xB8(Low)+0x0B(High)

Note: Conversion factor for VOUT_SET is $0.01 \cdot$ so $\frac{30V}{0.01} = 3000$

5.4.5.2 Reading data or status

The master reads the operation setting from the unit with the address "03" .

CAN ID	DLC(data length)	Command Code
0xC0103	0x02	0x0000

The unit with the address "03" returns the data below:

CAN ID	DLC(data length)	Command Code	Parameters
0xC0003	0x03	0x0000	0x01

Data:0x01 ON, means that the unit with the address "03" is operating.

5.4.5.3 Practical operation

The following steps will describe how to set the DRS-240-48 to 56V(for DRS-240-48, the output range is 40V~56V)

1. Confirm the address of the DRS-240-48

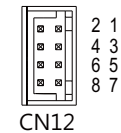

Between A0/A1 and GND(Single)	Logic
Open	1
Short	0

Device No.	Devices	Address
	A1	A0
0	0	0
1	0	1
2	1	0
3	1	1

Description	Message ID
Message ID of DRS	0x000C00XX
Message ID of Master	0x000C01XX
Broadcast	0x000C01FF

PS: XX means device address of DRS(depond on A0~A1,from0x00 to 0x03),so the address of the DRS-240-48 is 0xC0103.

2. Connect the CANH/CANL of the master to the corresponding CANH(PIN6) and CANL(PIN7) Pins of the RJ45 connector on the supply.

It is recommended to establish a common ground of the communication system to increase its communication reliability by using GND_AUX(PIN8) of RJ45.

- ◎ Set baud rate :250kbps,type:extended
- ◎ Adding a 120Ω termination resistor to both the controller and the supply's end can increase communication stability.
- ◎ If the unit is a terminal, it is recommended to connect a termination resistor.

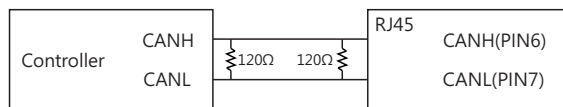

3. Set the output voltage to 56V.

CAN ID	DLC(data length)	Command Code	Parameters
0xC0103	0x04	0x2000	0xE015

Command code: 0x0020 (Vout_SET)

Data: 56V → 5600 → 0x15E0 → 0xE0(L0)+0x15(Hi)

Note: Conversion factor for VOUT_SET is 0.01 · so $\frac{56V}{0.01} = 5600$

4. It is recommended to review all of the settings and parameters using the appropriate commands. In the event that they do not meet your requirements ,you may rewrite them as needed.

EX: Read VOUT_SET to check whether output voltage was set to a propel level.

Read VOUT_SET:

CAN ID	DLC(data length)	Command Code
0xC0103	0x02	0x2000

The unit returns data below:

CAN ID	DLC(data length)	Command Code	Parameters
0xC0003	0x04	0x2000	0xE015

Data:0xE0(L0)+0x15(Hi)→0x15E0→5600= 56V

5. Finally, if there's no output voltage, to check whether tha AC is connected; if hot, you can short the PIN7. PIN8 of CN12 or long press the Battery start button for 3 sec then released, refer to chapter 5.7 for details.

5.4.4 Range and tolerance of values

(1) Reading parameters

	CANBus /Modbus Command	Model	Range	Tolerance	
0x0050	READ_VIN	ALL	80 ~305V	±5V	
0x0060	READ_VOUT	12V	0 ~15V	±0.12V	
		24V	0 ~30V	±0.24V	
		36V	0 ~45V	±0.36V	
		48V	0 ~60V	±0.48V	
0x0061	READ_IOUT	DRS-240	12V	0 ~20A	±0.2A
			24V	0 ~10A	±0.1A
			36V	0 ~6.6A	±0.066A
			48V	0 ~5A	±0.05A
		DRS-480	24V	0 ~20A	±0.2A
			36V	0 ~13.3A	±0.13A
0x0062	READ_TEMPERATURE_1	ALL	-40 ~ 110°C	±5°C	
0x00D3	READ_VBAT	12V	0 ~ 15V	±0.12V	
		24V	0 ~ 30V	±0.24V	
		36V	0 ~ 45V	±0.36V	
		48V	0 ~ 60V	±0.48V	
0x00D4	READ_IBAT	DRS-240	12V	-40~20A	±0.2A
			24V	-20~10A	±0.1A
			36V	-13.2~6.6A	±0.066A
			48V	-10~5A	±0.05A
		DRS-480	24V	-40~20A	±0.2A
			36V	-26.6~13.3A	±0.13A
0x00D5	READ_BAT_TEMPERATURE	ALL	-40 ~ 110°C	±5°C	

(2) Writing parameters

1	CANBus /Modbus Command	Model	Range	Tolerance	Default	
0x0000	OPERATION	ALL	00h(OFF)/01h (ON)	N/A	01h(ON)	
0x0020	VOUT_SET	12V	10 ~ 14V	±0.12V	12V	
		24V	20 ~ 28V	±0.24V	24V	
		36V	30 ~ 42V	±0.36V	36V	
		48V	40~56V	±0.48V	48V	
0x00B0	CURVE_ICHG	DRS-240	12V	4 ~ 20A	±0.2A	20A
			24V	2 ~ 10A	±0.1A	10A
			36V	1.32 ~ 6.6A	±0.066A	6.6A
			48V	1 ~ 5A	±0.05A	5A

0x00B0	CURVE_ICHG	DRS-480	24V	4 ~ 20A	±0.2A	20A
			36V	2.66 ~ 13.3A	±0.13A	13.3A
			48V	2 ~ 10A	±0.1A	10A
0x00B1	CURVE_VBST	12V	9 ~ 15V	±0.12V	14.4V	
		24V	18 ~ 30V	±0.24V	28.8V	
		36V	27 ~ 45V	±0.36V	43.2V	
		48V	36 ~ 60V	±0.48V	57.6V	
0x00B2	CURVE_VFLOAT	12V	9V ~ VBST	±0.12V	13.8V	
		24V	18V ~ VBST	±0.24V	27.6V	
		36V	27V ~ VBST	±0.36V	41.4V	
0x00B3	CURVE_ITAPER	DRS-240	12V	0.4 ~ 2A	±0.2A	2A
			24V	0.2 ~ 1A	±0.1A	1A
			36V	0.13 ~ 0.66A	±0.066A	0.66A
48V	0.1 ~ 0.5A		±0.05A	0.5A		
DRS-480	24V	0.4 ~ 2A	±0.2A	2A		
	36V	0.27 ~ 1.33A	±0.133A	1.33A		
	48V	0.2 ~ 1A	±0.1A	1A		
0x00B5	CURVE_CC_TIME OUT	ALL	60 ~ 64800 minute	±5 minute	600 minute	
0x00B6	CURVE_CV_TIME OUT					
0x00B7	CURVE_FLOAT_TIMEOUT					
0x00D0	BAT_UVP_SET	12V	9.6 ~ 12V	±0.12V	10.44V	
		24V	19.2 ~ 24V	±0.24V	20.88V	
		36V	28.8 ~ 36V	±0.36V	31.32V	
		48V	38.4 ~ 48V	±0.48V	41.76V	
0x00D1	Force_BAT_UVP_SET	12V	8.4 ~ 12V	±0.12V	8.4V	
		24V	16.8 ~ 24V	±0.24V	16.8V	
		36V	25.2 ~ 36V	±0.36V	25.2V	
		48V	33.6 ~ 48V	±0.48V	33.6V	
0x00E0	AC_Fail_LL_SET	ALL	82 ~ 120V	±5V	82Vac	
0x00E1	AC_Fail_HL_SET	ALL	132 ~ 182V	±5V	171.6Vac	
0x00E2	AC_OK_LL_SET	ALL	87~125V	±5V	87Vac	
0x00E3	AC_OK_HL_SET	ALL	137 ~ 187V	±5V	182.6Vac	
0x00E4	TIME_BUFFERING	ALL	60 ~ 64800 minute	±5sec	600 minute	
©	UPS_Delay_Time	ALL	60 ~ 300sec	±5sec	60sec	
	UPS_Shutdown_Time	ALL	0~60sec	±5sec	15sec	

NOTE:

•For ModBus , the address of UPS_Delay_Time is 0x00E8, the address of UPS_Shutdown_Time is 0x00E9;
 •For CANBus , the address of UPS_Delay_Time is 0x00E7, the address of UPS_Shutdown_Time is 0x00E8.

5.5 Alarm signals

Alarm signals: AC Fail, DC OK, Battery Low, Abnormality, Disconnection of batteries, and Charger Fail.

INPUT	AC Fail		DC OK		Battery low/Abnormal /Disconnected		Charger Fail	
	2-3	1-3	5-6	4-6	8-9	7-9	11-12	10-12
AC only	closed	open	closed	open	open	closed	-----	-----
AC + BAT.	closed	open	closed	open	closed	open	-----	-----
BAT. only	open	closed	closed	open	closed	open	-----	-----
Low BAT. (<30% capacity)	-----	-----	-----	-----	open	closed	-----	-----
Charger Fail	-----	-----	-----	-----	-----	-----	open	closed

1. Relays of " AC fail " , " DC OK " , " Battery low " or " Charger fail " will be triggered according to different abnormal condition.
2. An external voltage source is needed, and maximum voltage is 30Vdc and sinking current is 1A.

AC fail/DC OK/Battery low/Charger fail

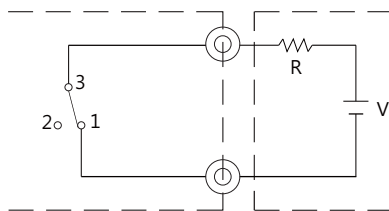

External voltage(V) and resistance(R)
(Maximal sinking current is 1A at 30V)

5.5.1 AC fail signal

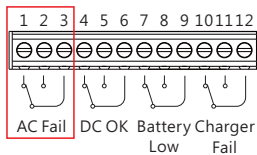

Status	2-3	1-3
Only supply by main power	Short	Open
Supply by main power and back-up power (battery)	Short	Open
Only supply by back-up power (battery)	Open	Short

5.5.2 DC OK signal

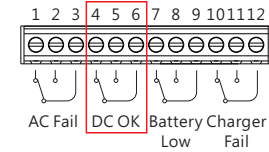

Status	5-6	
Normal DC output	Short	Open
DC fail	Open	Short

5.5.3 Battery Low, reverse polarity, disconnected battery signal

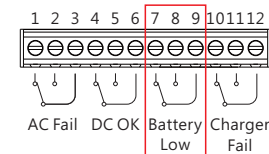

Status	8-9	7-9
Normal battery voltage	Short	Open
Low	Open	Short

5.5.4 Charger Fail signal

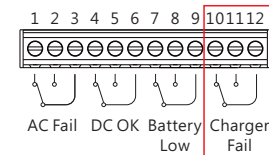

Status	11-12	10-12
Normal charging	Short	Open
Abnormal	Open	Short

Description of the Relay status

The status of the DRS :	The status of the Charger FAIL relay
Charging · the LED is orange	Charger OK
Completed 3 stage charging process, enters the floating charge · and the LED is green	Charger OK
Completed 2 stage charging process, shuts down the charging loop, the LED is green, and will restart the charging process when the voltage of the battery drops to 80% of Vboost	Charger OK
Charging loop anomaly	Charger FAIL
UPS mode · the battery is discharging	Charger FAIL
BAT_NC(the battery is not connected),shuts down the charging loop. When the battery is detected, it will be charged	Charger FAIL
Remote off · shut down	Charger FAIL

Protection :	The status of the Charger FAIL relay
Charge_Timeout(Charge timeout protection), shuts down the charging loop, no more charging if there is no restart	Charger FAIL
2or3 times peak load · the battery discharges for 4min/4sec	Charger FAIL
OLP (Over load protection) , Shuts down	Charger FAIL
OTP · shuts down	Charger FAIL
OVP · shuts down	Charger FAIL
Battery reverse protection · shuts down	Charger FAIL
The device is damaged, no output, shuts down	Charger FAIL
EEPROM ERROR · shuts down	Charger FAIL
SCP (Output short-circuit protection) , shuts down	Charger FAIL

5.6 Battery start by battery start button

The function of the mode is to restart the system directly from the existed battery or a replaced one and this does not require AC power to activate.

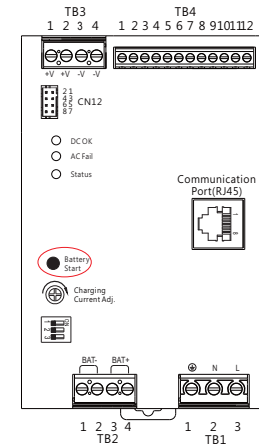

5.6.1 Short press the Battery Start button to connect to the battery to start the mode.

5.6.2 Long pressing the Battery Start button for 3sec can release the connection from the battery to deactivate the mode.

5.6.3 Battery under-voltage protection will be triggered and then disconnecting from the battery when battery voltage drops below a certain value(12V: 10.5±0.3V; 24V:20.9±0.5; 36V:31.3±0.7V; 48V : 41.8±1V)

5.6.4 In the mode, if there is AC power fed in, the supply will switch to using AC energy and then recharge the battery automatically.

5.7 Battery start by force button

The function of the mode is to restart the system directly from the existed battery or a replaced one and this does not require AC power to activate.

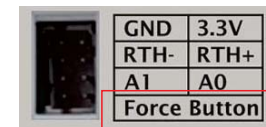

- 5.7.1 Short-circuit PIN 7 and PIN 8 of CN12 together to activate the mode (after activation, it is recommended to disconnect the connection in order not to interfere in the function of 5.7.2) Short circuit on PIN7 and PIN8 of CN12(Open or remain shorted).
- 5.7.2 Long pressing the Battery Start button for 3sec can release the connection from the battery to deactivate the mode.
- 5.7.3 Battery under-voltage protection will be triggered and then disconnecting the battery when battery voltage drops below a certain value (12V : $10\pm 0.3V$; 24V : 16.8 ± 0.5 ; 36V : $25.2\pm 0.7V$; 48V : $33.6\pm 1V$)
- 5.7.4 In the mode, if there is AC power fed in, the supply will switch to using AC energy and then recharge the battery automatically.

5.8 Battery temperature compensation

The main function of temperature compensation is to reduce the influences of temperature on battery. Using this function, please put the shipped temperature sensor (NTC) on the battery or near it. DRS can work normally without temperature sensor (NTC) .

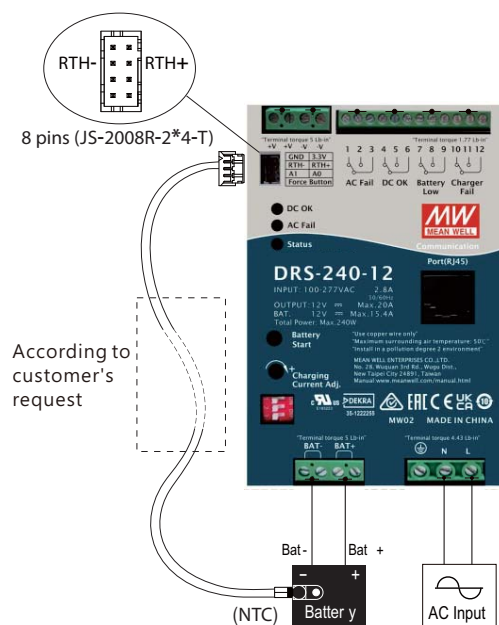

- 5.8.1. CANBus and Modbus commands can modify parameters of temperature compensation. There are four selections, Disable, $-3mV/^{\circ}C/Cell$, $-4mV/^{\circ}C/Cell$ and $-5mV/^{\circ}C/Cell$, and default setting is $-3mV/^{\circ}C/Cell$.
- 5.8.2. No compensation if temperature sensor disconnected. Only Lead-acid batteries can use this compensation.
- 5.8.3. Temperature range for compensation is $0-40^{\circ}C$. No compensation at middle value $25^{\circ}C$ and temperature $<0^{\circ}C$ or $>40^{\circ}C$ will be limited at the maximum and minimum boundary. For 24V model as example, assume V_{boost} is 28.8V, compensation parameter is $-5mV/^{\circ}C/Cell$, TEMP_bat is the sensing temperature of NTC, then compensated voltage can be calculated below.

$$V_{boost_comp} = 28.8V - 5mV * (TEMP_bat - 25^{\circ}C) * 12Cell$$

$$V_{boost_H} = 28.8V - 5mV * (0^{\circ}C - 25^{\circ}C) * 12Cell = 30.3V$$

$$V_{boost_L} = 28.8V - 5mV * (40^{\circ}C - 25^{\circ}C) * 12Cell = 27.9V$$

5.8.4 Accessories

※ Standard accessories of DRS: NTC sensor and remote-control cable

	Item	Amount
1	<p>NTC sensor</p> <p>Part No.: NGS05C250J5</p>	1
2	<p>Remote-control cable</p>	1
<p>Conne</p>		

5.9 Power boost mode

5.9.1 No battery connection

Power supply can remain 115% of rated power, then shut down after 5 sec.

5.9.2 With battery connected

The maximum current on the load output is the 2 times the rated current for 4 minutes max.

The maximum current on the load output is the 3 times the rated current for 4 seconds max.

For example (48V model):

- When maximum output current draw doubles the rated current, the maximum output period is 4 minutes, and 4 seconds at triple current draw.

Output power



- Taking 10 minutes as cycle unit, the period of double power can not exceed 6 minutes or triple less than 6 seconds – otherwise DRS will automatically shut down for protection.

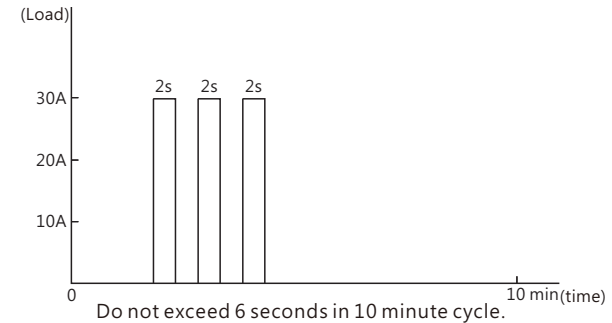
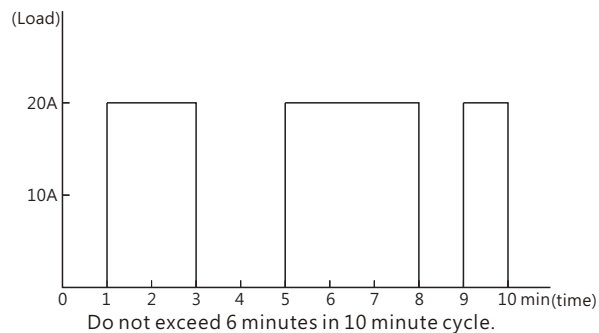

5.10 Restore factory default setting

Users can restore these parameters in parentheses (0x0020, 0x0020, 0x0030, 0x00B0~0x00B7, 0x00C2, 0x00E0~0x00E4) to factory setting by using the following the steps below:

- After supplying AC input power AC, shortly push Bat_start button 5 times in 15 seconds.
- LED indicator (Status indicator) will flash 3 times in green and that means the setting is succeeded.
- Recycle the supply to restore factory default setting.

6. Protection and Failure Correction

6.1 Protections

6.1.1 Over load protection

When output current reaches the protection criteria, power supply will limit its output as constant current, and shut down for protection after 5 seconds. Re-power on to recover.

6.1.2 Over temperature protection

When the internal temperature of power supply is too high, power supply will shut down for protection and it will turn on automatically if the temperature is back to normal range.

In charging mode, when the internal temperature of power supply is too high, power supply will automatically decrease output power according to the derating curve, chapter 2.5. If the temperature is still too high over limitation, power supply will shut down and recover once the temperature cool down.

6.1.3 Output over voltage protection

When output voltage over specification, over voltage protection will be activated, and power supply shuts down. When the faulty condition removed, re-power on to remove the protection.

6.1.4 Battery under voltage protection

When the voltage of battery is too low, power supply will shut down.

Model	Protection limitation
12V	10.5 ±0.3V
24V	20.9 ±0.5V
36V	31.3±0.7V
48V	41.8±1.0V

Note: If battery under-voltage protection is triggered by force button, please refer to 5.7.3.

6.1.5 Reverse polarity protection

Power supply has built-in MOSFETs to achieve reverse polarity protection. When the faulty condition removed, power supply will automatically recover without damage.

6.2 Failure correction

Status	Possible cause	Suggestion for fault correction
Battery back-up failure	Un-connected, low voltage battery	Check connection, specification of battery, or change battery
Battery start failure	Button: low battery voltage/reverse connection	Check connection or change new battery
	CN12: bad connection	Make sure PIN7&8 of CN12 well-connected
Automatically shut down under suitable AC input	Battery discharging peak power over time (Red LED flashes at 4 pulses)	Check load condition and re-power on.
	Over temperature (Red LED flashes at 6 pulses)	Cool down temperature and re-power on.
	Over voltage (Red LED flashes at 2 pulses)	Check specification of battery
	Short circuit (Red LED flashes at 5 pulses)	Eliminate abnormal condition and re-power on.
Battery can not be fully charged	Aged battery or malfunction	Change new batteries
	Small cross-section of cable	Choose a proper cable for usage
	Wrong charging curve	Double check the characteristic of battery

Note : 1. Refer to chapter 4.3 for LED indicator.

2. Please contact MEAN WELL's distributor if above faulty condition is not removable.

7.Warranty

This product provides three years warranty under normal usage. Do not replace parts or any form of modification to the product in order to keep the warranty effectively.

※ MEAN WELL possess the right to adjust the content of this manual. Please refer to the latest version of our manual on our website.
<https://www.meanwell.com>



8.Environmental declaration information

https://www.meanwell.com//Upload/PDF/RoHS_PFOS.pdf

https://www.meanwell.com//Upload/PDF/REACH_SVHC.pdf

https://www.meanwell.com//Upload/PDF/Declaration_RoHS-E.pdf

明緯企業股份有限公司

MEAN WELL ENTERPRISES CO., LTD.

248 新北市五股區五權三路28號

No.28, Wuquan 3rd Rd., Wugu Dist., New Taipei City 248, Taiwan

Tel: 886-2-2299-6100 Fax: 886-2-2299-6200

<http://www.meanwell.com> E-mail: info@meanwell.com